



SERTPLAS[®]
SYSTEMS

**2019-2020
PRODUCT
CATALOGUE**



ELECTRIC

LIGHTING

AIR



Company Profile

SERTPLAS is a well-established technology manufacturer that takes its power from the principles of perfect production and ultimate customer satisfaction.

SERTPLAS is providing design, development, manufacturing, assembly and other various services to OEMs and commercial vehicle aftermarket in accordance with the IATF 16949 quality standards.

The Research and Development center established within the company, SERTPLAS is producing 100 % domestic, high technology products that include embedded software in their core.

SERTPLAS is representing Turkish design and engineering in the global arena by exporting 72 % of its production.

Company History

SERTPLAS stepped into the market in 1955 as a small plastic injection shop, by its founder Hasan Serter (1931 - 2002). Today the company is operating out of a vertically integrated complete production facility established on an area of 40,000m² with net production area of 11,500m², supplying both the aftermarket and OEMs.

In addition to truck and trailer lighting equipment, SERTPLAS expanded its product portfolio to include electrical/electronic systems, electric cables, connectors, body parts, air brake hoses and couplings, convertors and regulators.

By paying close attention to the market dynamics and changing customer requirements, SERTPLAS is proudly exporting 72 % of its production to 60 countries in Europe, Africa, Middle East, Asia and South America, as well as directly working with OEMs around the globe as a preferred Tier 1 supplier.

From design to mass production, SERTPLAS is proud to be a preferred solution partner for many customers around the world.

Our Vision

To further build our brand as a globally leading technology manufacturer for electric and heavy duty vehicles.

Our Mission

- ❖ Without sacrificing quality, to keep customer satisfaction at the highest level and always move our production forward by using the state of the art manufacturing principles and techniques.
- ❖ Investing in Research and Development projects that re-define the future of the industries that we participate in.
- ❖ Expand the limits of our internal expertise to provide new products that address the future challenges of our clients
- ❖ We create an environment in which our colleagues can grow and explore their potential in moving our collective effort that is called SERTPLAS further.

Şirket Profili

Müşteri memnuniyetini ilke edinmiş köklü bir şirket olan SERTPLAS, gücünü daima yeni teknolojilerle beslediği kusursuz üretim anlayışından alıyor.

SERTPLAS, IATF 16949 kalite standartları çerçevesinde otomotiv ve ağır vasıta üreticilerine tasarım, geliştirme, üretimi, montaj ve servis hizmetleri sunmaktadır.

Bünyesinde kurduğu Araştırma ve Geliştirme merkezi ile gömülü yazılım içeren yüksek teknoloji ürünleri de % 100 yerli olarak üretmeye başlamıştır.

Üretimini % 72' sini ihraç eden SERTPLAS, Türk tasarım ve mühendisliğini uluslararası arenada temsil etmektedir.

Tarihçe

SERTPLAS, 1955 yılında İstanbul'da kurucusu Hasan Serter tarafından küçük bir enjeksiyon atölyesi olarak iş dünyasına adım attı. Bugün ise, 40.000 m² arazi üzerinde 11.500 m² kapalı alan altında 260 çalışanı ile otomotiv yedek parça sektörüne hizmet vermektedir.

Ağırlıklı olarak kamyon ve treylerler için aydınlatma ve sinyalizasyon parçaları, elektrik/elektronik sistemler, elektrik kabloları, konnektörler, araç gövde parçaları, çamurluklar, hava hortumları, fren hava kaplinleri, konvertör ve regülatör gibi ürünlerin üretimini gerçekleştirmektedir.

Pazardaki değişim ve gereksinimlere verilen önem sayesinde, bugün üretimini % 72'sini Avrupa, Afrika, Orta Doğu, Asya, Güney Amerika dahilinde 60'a yakın ülkeye, aynı zamanda da OE üreticilerine ihraç etmekten gurur duymaktadır.

Tasarımdan seri üretime, SERTPLAS dünya çapında bir çok müşterisi tarafından tercih edilen çözüm partneri olarak tedarikçi listelerinde yer almaktadır.

Vizyonumuz

Elektrikli otomobil ve ağır vasıta tedarik sektöründe SERTPLAS markasını yüksek teknoloji ürünler üreten lider tedarikçi markalardan biri haline getirmek.

Misyonumuz

- ❖ Kaliteden ödün vermeden, en son teknoloji üretim teknik ve teknolojilerini kullanarak müşteri memnuniyetini en üst seviyede tutmak.
- ❖ Geleceği yeniden tanımlayan Araştırma ve Geliştirme projelerine yatırım yaparak hizmet verdiğimiz sektörlere yüksek teknoloji ürünlerimizi sunmak.
- ❖ Şirket bünyesindeki uzmanlıklarımızı sürekli geliştirerek müşterilerimizin gelecekte karşılaştıkları problemlere şimdiden çözümler üreten ürünler tasarlamak.
- ❖ İş arkadaşlarımızın kendilerini sürekli geliştirebileceği bir ortam yaratarak ortak değerimiz olan SERTPLAS firmasını ileriye taşımalarına destek olmak.

Contents

	Page
TRAILER PARTS	1-64
COMPLETE LIGHTING SETS FOR TRAILER (DORSET)	1-22
Spare Parts For Complete Lighting Sets	20-22
LIGHTING	23-52
Tail Lamps	23-33
Marker Lamps	34-36
Side Marker & Indicator Lamps	37-46
Indoor Ceiling Lamps	47
Number Plate Lamps	48
Reflectors	49-52
AIR PRESSURE AND BRAKING PARTS FOR TRAILER	53-54
AIR BRAKE CONNECTION FITTINGS FOR TRAILER	55-56
EQUIPMENTS & ACCESSORIES FOR TRAILER	57-64
TRUCK PARTS	65-166
ELECTRICAL COILS, PLUGS & SOCKETS FOR TRUCK	65-99
AIR PRESSURE AND BRAKING PARTS FOR TRUCK	100-102
TAIL LAMPS FOR TRUCK	103-124
VV FH TRUCK LIGHTING	125-136
SC TRUCK LIGHTING	137
MRC TRUCK LIGHTING	138-144
RN TRUCK LIGHTING	145-148
MUDGUARDS & BODY PARTS FOR TRUCK	149-152
ROTATING BEACONS	153-155
WORKING LIGHT FOR TRUCK	156-157
TRUCK EQUIPMENTS & ACCESSORIES	158-161
GENERAL ELECTRICAL PARTS	162-166
COMMERCIAL VEHICLE LIGHTING	167-173

İçindekiler

Sayfa

DORSE YEDEK PARÇALARI	1-64
TIR DORSELERİ İÇİN KOMPLE AYDINLATMA SETLERİ	1-22
Aydınlatma Seti Parçaları.....	20-22
AYDINLATMA PARÇALARI	23-52
Arka İşaret Lambaları.....	23-33
İşaret Lambaları.....	34-36
Yan İşaret Lambaları.....	37-46
İç Aydınlatma Lambaları.....	47
Plaka Aydınlatma Lambaları.....	48
Reflektörler.....	49-52
TIR DORSELERİ İÇİN HAVA VE FREN PARÇALARI	53-54
TIR DORSELERİ İÇİN FREN BAĞLANTI (FITTINGS) PARÇALARI	55-56
TIR DORSELERİ İÇİN EKİPMAN VE AKSESUARLAR	57-64
TIR ÇEKİCİ YEDEK PARÇALARI	65-166
TIR ÇEKİCİLER İÇİN ELEKTRİK BAĞLANTI KABLOLARI, FİŞLER VE SOKETLER	65-99
TIR ÇEKİCİLER İÇİN HAVA VE FREN PARÇALARI	100-102
TIR ÇEKİCİLER İÇİN ARKA İŞARET LAMBALARI	103-124
VV FH TIR ÇEKİCİ AYDINLATMA PARÇALARI	125-136
SC TIR ÇEKİCİ AYDINLATMA PARÇALARI	137
MRC TIR ÇEKİCİ AYDINLATMA PARÇALARI	138-144
RN TIR ÇEKİCİ AYDINLATMA PARÇALARI	145-148
TIR ÇEKİCİLER İÇİN ÇAMURLUK VE GÖVDE PARÇALARI	149-152
DÖNER LAMBALAR	153-155
TIR ÇEKİCİLER İÇİN ÇALIŞMA LAMBALARI	156-157
TIR ÇEKİCİLER İÇİN EKİPMAN VE AKSESUARLAR	158-161
TIR ÇEKİCİLER İÇİN GENEL ELEKTRİK PARÇALARI	162-166
TİCARİ ARAÇ AYDINLATMA PARÇALARI	167-173

ADR CERTIFICATION

CERTIFICATION **ADR** REPORT NO CV15110231

CONCERNING THE DECLARATION OF CONFORMITY OF AN ELECTRICAL INSTALLATION
KIT FOR USE IN TRAILERS ACCORDING TO REQUIREMENTS OF ADR REGULATION

Sertplas A.Ş.

Telephone: +90 212 5490555

Fax: +90 212 5490105

İkitelli Organize Sanayi.Bölgesi. Dolapdere Sanayi.Sitesi

Ada:25 No:10 Basaksehir / Istanbul / Turkey

E- mail : sp@sertplas.com.tr

Trade mark : Sertplas Date / 16/09/2011

The installation kit "ADR LIGHT SET" presented under the **SERTPLAS** brand **TRAIL- TECH** fulfils the prescriptions concerning its conformity with requirements of ADR Regulation.

TECHNICAL STANDARDS USED FOR EVALUATION

ADR 2011

ECE R105

ISO 4091

ISO 6722

ISO 7638

ISO 14572

EN 60079

EN 60529

CABLES

4*1.5+3*2.5 FLRY (C1); 1*2.5+6*1.5 FLRY (C2) ; 2*1.5 FLRY (C3) ; 3*2.5+10*1.5 FLRY11Y (C4);
5*1+1*2.5 FLRY11Y (C5)

The requirements of ADR Regulation are fulfilled for connectors.

Junction boxes (J4) have a protection degree of IP54 according to EN 60529

The connectors (J1, J2, J3, J5, J6, J7) have a protection degree of IP54 according to EN 60529

The connectors must be protected against self-loose. The boxes must be protected against mechanical damage or must be installed protectedly

The lamps (L1, L2, L3, L4, L5) meet the requirements of EN 60079

The lamps (L1, L2, L3, L4, L5) have a protection degree of IP54 according to EN 60529

The lamps have a surface temperature in the range from 32°C up to 134°C

The requirements of ADR Regulation are fulfilled

Conclusions

The installation kit whose components are referenced above fulfils the requirements of ADR Regulation, issue 2015 and ECE R105.02 paragraph 5.1.1 for the installation in vehicles of types AT, FL, OX, EX/II and EX/III, except vehicles referred to in special provision V8, no. 3, R3 and R5

ADR CERTIFICATIONS FOR CABLES

TÜV SÜD Auto Service GmbH
Westendstrasse 199
D-80686 München

Auto Service

Prüfbericht-Nr. / Test-Report-No.: 16-00313-CC-GBM-00
Hersteller / manufacturer: SERTPLAS OTO YAN SAN.VE TIC.A.S., Silivri-istanbul (Turkey) Seite / page 1 von / of 5
Typ / type: ADR – FLYYY – PVC cable

Prüfbericht
Test-Report

Beurteilung einer elektrischen Mantelleitung auf Übereinstimmung mit den Anforderungen des ADR /
Approval of an electrical sheathed cable in accordance with the requirements of ADR

Name und Anschrift des Prüflaboratoriums /
Name and address of the Test Laboratory : TÜV SÜD Auto Service GmbH
Daimlerstraße 13, D-85748 Garching

Name und Anschrift des Antragstellers /
Name and address of orderer : SERTPLAS®
OTO YAN SAN. VE TIC. A.Ş.

SERTPLAS OTO YAN SAN.VE TIC.A.S.,
Laiklik Cad. Hançer Sok.
No:16 34570 Büyükkıçır, Silivri-istanbul, Turkey

1. Vorgang **1. Scope**

Eine Familie elektrischer Mantelleitungen, vorge-
sehen für den Einsatz in bestimmten Beförde-
rungseinheiten zur Beförderung gefährlicher Gü-
ter, soll auf Übereinstimmung mit den Anforderun-
gen des ADR beurteilt werden.

A family of sheathed electrical cables due to use in
special transport units for the carriage of dangerous
goods should be approved on the requirements of
ADR

2. Auftragsdatum: **2. Date of order**
30.09.2016 2016-09-30

TÜV SÜD Auto Service GmbH
Westendstrasse 199
D-80686 München

Auto Service

Prüfbericht-Nr. / Test-Report-No.: 16-00314-CC-GBM-00
Hersteller / manufacturer: SERTPLAS OTO YAN SAN.VE TIC.A.S., Silivri-istanbul (Turkey) Seite / page 1 von / of 5
Typ / type: ADR – FLYY11Y – TPU cable

Prüfbericht
Test-Report

Beurteilung einer elektrischen Mantelleitung auf Übereinstimmung mit den Anforderungen des ADR /
Approval of an electrical sheathed cable in accordance with the requirements of ADR

Name und Anschrift des Prüflaboratoriums /
Name and address of the Test Laboratory : TÜV SÜD Auto Service GmbH
Daimlerstraße 13, D-85748 Garching

Name und Anschrift des Antragstellers /
Name and address of orderer : SERTPLAS®
OTO YAN SAN. VE TIC. A.Ş.

SERTPLAS OTO YAN SAN.VE TIC.A.S.,
Laiklik Cad. Hançer Sok.
No:16 34570 Büyükkıçır, Silivri-istanbul, Turkey

1. Vorgang **1. Scope**

Eine Familie elektrischer Mantelleitungen, vorge-
sehen für den Einsatz in bestimmten Beförde-
rungseinheiten zur Beförderung gefährlicher Gü-
ter, soll auf Übereinstimmung mit den Anforderun-
gen des ADR beurteilt werden.

A family of sheathed electrical cables due to use in
special transport units for the carriage of dangerous
goods should be approved on the requirements of
ADR

2. Auftragsdatum: **2. Date of order**
30.09.2016 2016-09-30

TÜV SÜD Auto Service GmbH
Westendstrasse 199
D-80686 München

Auto Service

Prüfbericht-Nr. / Test-Report-No.: 16-00315-CC-GBM-00
Hersteller / manufacturer: SERTPLAS OTO YAN SAN.VE TIC.A.S., Silivri-istanbul (Turkey) Seite / page 1 von / of 5
Typ / type: ADR – FLYYW13Y – TPE cable

Prüfbericht
Test-Report

Beurteilung einer elektrischen Mantelleitung auf Übereinstimmung mit den Anforderungen des ADR /
Approval of an electrical sheathed cable in accordance with the requirements of ADR

Name und Anschrift des Prüflaboratoriums /
Name and address of the Test Laboratory : TÜV SÜD Auto Service GmbH
Daimlerstraße 13, D-85748 Garching

Name und Anschrift des Antragstellers /
Name and address of orderer : SERTPLAS®
OTO YAN SAN. VE TIC. A.Ş.

SERTPLAS OTO YAN SAN.VE TIC.A.S.,
Laiklik Cad. Hançer Sok.
No:16 34570 Büyükkıçır, Silivri-istanbul, Turkey

1. Vorgang **1. Scope**

Eine Familie elektrischer Mantelleitungen, vorge-
sehen für den Einsatz in bestimmten Beförde-
rungseinheiten zur Beförderung gefährlicher Gü-
ter, soll auf Übereinstimmung mit den Anforderun-
gen des ADR beurteilt werden.

A family of sheathed electrical cables due to use in
special transport units for the carriage of dangerous
goods should be approved on the requirements of
ADR

2. Auftragsdatum: **2. Date of order**
30.09.2016 2016-09-30

TÜV SÜD Auto Service GmbH
Westendstrasse 199
D-80686 München

Auto Service

Prüfbericht-Nr. / Test-Report-No.: 16-00316-CC-GBM-00
Hersteller / manufacturer: SERTPLAS OTO YAN SAN.VE TIC.A.S., Silivri-istanbul (Turkey) Seite / page 1 von / of 5
Typ / type: ADR – FLYYYF – flat PVC cable

Prüfbericht
Test-Report

Beurteilung einer elektrischen Mantelleitung auf Übereinstimmung mit den Anforderungen des ADR /
Approval of an electrical sheathed cable in accordance with the requirements of ADR

Name und Anschrift des Prüflaboratoriums /
Name and address of the Test Laboratory : TÜV SÜD Auto Service GmbH
Daimlerstraße 13, D-85748 Garching

Name und Anschrift des Antragstellers /
Name and address of orderer : SERTPLAS®
OTO YAN SAN. VE TIC. A.Ş.

SERTPLAS OTO YAN SAN.VE TIC.A.S.,
Laiklik Cad. Hançer Sok.
No:16 34570 Büyükkıçır, Silivri-istanbul, Turkey

1. Vorgang **1. Scope**

Eine Familie elektrischer Mantelleitungen, vorge-
sehen für den Einsatz in bestimmten Beförde-
rungseinheiten zur Beförderung gefährlicher Gü-
ter, soll auf Übereinstimmung mit den Anforderun-
gen des ADR beurteilt werden.

A family of sheathed electrical cables due to use in
special transport units for the carriage of dangerous
goods should be approved on the requirements of
ADR

2. Auftragsdatum: **2. Date of order**
30.09.2016 2016-09-30

ISO CERTIFICATION



Certificate of Registration

This certificate has been awarded to

SERTPLAS OTO YAN. SAN. VE TİC. A.Ş.

İkitelli Org. San. Bölğ. 14.Cad. Mutsan San. Sit. M-9 Blok No:9-11
Başakşehir, Şube: Laiklik Cad. Haçer Sok. No:16 34570 Büyükkılıçlı Mah.
Silivri İSTANBUL, Turkey

in recognition of the organization's Quality Management System which complies with

ISO 9001:2015

The scope of activities covered by this certificate is defined below

Please refer to the Appendix

Certificate Number:

75141/B/0002/UK/En

Date of Issue: (Original)

22 June 2016

Date of Issue:

22 September 2017

Issue No:

3

Expiry Date:

21 June 2019

Issued by:



On behalf of the Schemes Manager



ISO CERTIFICATION



Appendix to Certificate

Foreign Trade, Customs Clearance, Management and Administrative Organization Activities and Operations Associated with These Activities and Production and Delivery of Services Related to These Activities of Design and Manufacture of Automotive Lighting Systems, Electrical Systems, Pneumatic Systems, Air Brake Systems and Body Parts

Certificate Number:

75141/B/0002/UK/En

Issue No:

3

Date of Issue: (Original)

22 June 2016

Expiry Date:

21 June 2019

Date of Issue:

22 September 2017



If there is any doubt as to the authenticity of this certificate, please do not hesitate to contact the Head Office of the Group on info@urs-certification.com. URS is a member of United Registrar of Systems (Holdings) Ltd, Derby Manor, Derby Road, Bournemouth, BH1 5QB, UK. Company Registration no. 5208468

Page 2 of 2

ISO CERTIFICATION



Certificate of Registration

This certificate has been awarded to

SERTPLAS OTO YAN. SAN. VE TİC. A.Ş.

Laiklik Cad. Hançer Sok. No:16 34570 Büyükkılıç Mahallesi Silivri
İSTANBUL, Turkey

in recognition of the organization's Quality Management System which complies with

IATF 16949:2016

The scope of activities covered by this certificate is defined below

Manufacture of Lighting Systems, Electrical Systems, Pneumatic Systems and Air Brake Systems (Excludes Product Design under Clause 8.3)

Certificate Number:

75141/B/0001/SM/En

Date of Issue of Certification Cycle:

04 June 2018

Issue No:

1

Expiry Date:

03 June 2021

IATF No:

0308364

Issued by:



On behalf of the Schemes Manager



ISO CERTIFICATION



Certificate of Registration

This certificate has been awarded to

SERTPLAS OTO YAN. SAN. VE TİC. A.Ş.

İkitelli Org. San. Böl. 14. Cad. Mutsan San. Sit. M-9 Blok No:9-11
Başakşehir, Şube: Laiklik Cad. Hançer Sok. No:16 34570 Büyükkılıç Mah.
Silivri İSTANBUL, Turkey

in recognition of the organization's Environmental Management System which complies with

ISO 14001:2015

The scope of activities covered by this certificate is defined below

Design and Manufacture of Automotive Lighting Systems, Electrical Systems, Pneumatic Systems and Air Brake Systems

Certificate Number:

75141/A/0002/UK/En

Date of Issue: (Original)

27 April 2016

Date of Issue:

04 July 2017

Issue No:

3

Expiry Date:

26 April 2019

Issued by:

On behalf of the Schemes Manager



If there is any doubt as to the authenticity of this certificate, please do not hesitate to contact the Head Office of the Group on info@urs-certification.com.
URS is a member of United Registrar of Systems (Holdings) Ltd, Derby Manor, Derby Road, Bournemouth, BH1 3CB, UK. Company Registration no. 5298468

Page 1 of 1

ISO CERTIFICATION



Certificate of Registration

This certificate has been awarded to

SERTPLAS OTO YAN. SAN. VE TİC. A.Ş.

Laiklik Cad. Haçer Sok. No:16 34570 Büyükkılıçlı Mahallesi Silivri
İSTANBUL, Turkey

in recognition of the organization's Information Security Management System which complies
with

ISO 27001:2013

The scope of activities covered by this certificate is defined below

**PROTECTING ASSETS USED FOR AUTOMOTIVE LIGHTING SYSTEMS,
ELECTRIC SYSTEMS, PNEUMATIC SYSTEMS, AIR BRAKE SYSTEMS
AND BODY PARTS PRODUCTION AND DESIGN, FOREIGN TRADE,
LOGISTICS, STORAGE, ACCOUNTING AND FINANCE. SOA Rev2,
25/2/2019**

Certificate Number:

75141/C/0001/UK/En

Issue No:

1

Date of Issue: (Original)

08 March 2019

Expiry Date:

07 March 2022

Date of Issue:

08 March 2019

Issued by:



On behalf of the Schemes Manager



If there is any doubt as to the authenticity of this certificate, please do not hesitate to contact the Head Office of the Group on info@urs-certification.com.
URS is a member of United Registrar of Systems (Holdings) Ltd, United House, 4 Hinton Road, Bournemouth, BH1 2EE, UK. Company Registration no. 5298496

Page 1 of 1

EAC CERTIFICATION

ТАМОЖЕННЫЙ СОЮЗ	
СЕРТИФИКАТ СООТВЕТСТВИЯ	
№ ТС <u>RU C-TR.OC13.B.02872</u>	
Серия RU № 0453079	
ОРГАН ПО СЕРТИФИКАЦИИ Общество с ограниченной ответственностью "НТЦ АВТОЭКСПЕРТ", Место нахождения: 117292, Российская Федерация, город Москва, улица Кедрова, дом 4, корпус 2, помещение V, комната 1. Фактический адрес: 119334, Российская Федерация, город Москва, проспект Ленинский, дом 32А. Телефон: +74952681225, факс: +74952681225, адрес электронной почты: info@ntc-ae.ru. Аттестат аккредитации регистрационный № RA.RU.11OC13 выдан 27.03.2015 года Федеральной службой по аккредитации	
ЗАЯВИТЕЛЬ Общество с ограниченной ответственностью «Ч-Траст». Основной государственный регистрационный номер: 1055005912543. Место нахождения: 142432, Российская Федерация, Московская область, город Черноголовка, Школьный бульвар, дом 10. Фактический адрес: 142432, Российская Федерация, Московская область, город Черноголовка, Школьный бульвар, дом 10. Телефон: 79262110703, факс: 74965225111, адрес электронной почты: asaf@bk.ru	
ИЗГОТОВИТЕЛЬ «SERTPLAS OTO YAN SANAYI VE TIC.A.S.» Место нахождения: ТУРЦИЯ, Ikitelli Organize K.S.Sitesi Bolgesi, 14. Cadde, Mutfakcılar sanayi Sitesi, M-9 Blok, No:1-3-5-7-9-11, 34490 – Basaksehir İSTANBUL. Фактический адрес: ТУРЦИЯ, Ikitelli Organize K.S.Sitesi Bolgesi, 14. Cadde, Mutfakcılar sanayi Sitesi, M-9 Blok, No:1-3-5-7-9-11, 34490 – Basaksehir İSTANBUL	
ПРОДУКЦИЯ Компоненты, поставляемые в качестве сменных (запасных) частей для послепродажного технического обслуживания и ремонта автотранспортных средств и автоприцепов торговых марок «SERTPLAS», «TRAIL-TECH» (смотри приложение - бланки №№ 0315390, 0315391). Продукция изготовлена в соответствии с Директивой 2007/46/ЕС. Серийный выпуск	
КОД ТН ВЭД ТС 8512 20 000 9, 7009 10 000 9, 3926 90 970 7	
СООТВЕТСТВУЕТ ТРЕБОВАНИЯМ Технического регламента Таможенного союза ТР ТС 018/2011 "О безопасности колесных транспортных средств"	
СЕРТИФИКАТ ВЫДАН НА ОСНОВАНИИ Сообщений об официальном утверждении типа (смотри приложение - бланк № 0315393).	
ДОПОЛНИТЕЛЬНАЯ ИНФОРМАЦИЯ Условия хранения, срок хранения (службы, годности) продукции указаны в прилагаемой к продукции эксплуатационной документации.	
СРОК ДЕЙСТВИЯ С <u>20.10.2016</u> ПО <u>19.10.2020</u> ВКЛЮЧИТЕЛЬНО	
	Руководитель (уполномоченное лицо) органа по сертификации _____ (подпись)
Эксперт (эксперт-аудитор) (эксперты (эксперты-аудиторы)) _____ (подпись)	В.П. Соловьев _____ (инициалы, фамилия)
	А.В. Бакулин _____ (инициалы, фамилия)

EVC

Type 2 Electric Vehicle Charging Cable Tip 2 Elektrikli Araç Şarj Kablosu

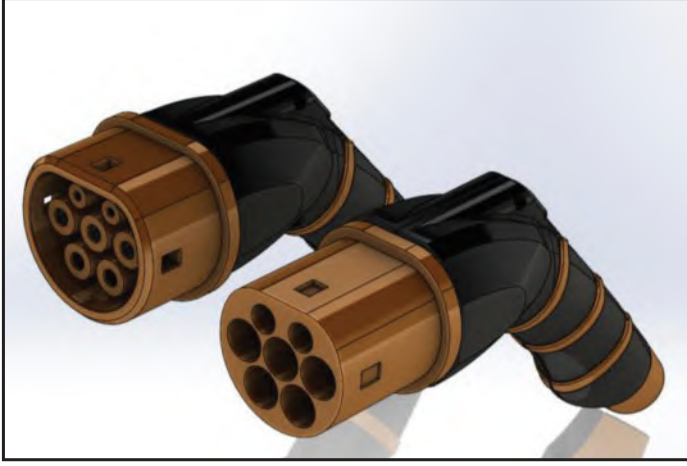

High quality electric vehicle charging cable for Type 2 (EN 62196-2) charging. Product includes vehicle connector and infrastructure plug with prospective caps for maximum protection. 16 A and 32 A versions with 1 phase and 3 phases available for 230 / 440 V (AC) charging.

Please inquire for the availability of the product by 3rd quarter 2019
2019 3. çeyrekte sonra ürün satışları başlayacaktır.

Custom cable lengths are available according to the client specifications
Gelecek taleplere göre ürün kablo uzunluğu müşteri isteklerine göre değiştirilebilir.

5 meter cable 5 metre kablolu	EVC3235	EVC3215
Max charging power Maksimum şarj gücü	14 kW	7,4 kW
Rated current Akım değeri	32	32
Number of phases Faz adedi	3	1
Number of power contacts Güç kontağı sayısı	5 (L1, L2, L3, N, PE)	3 (L1, N, PE)
Rated voltage Voltaj değeri	440	230
Cable structure Kablo yapısı	5 x 6.0 mm ² + 1 x 0.5 mm ²	5 x 6.0 mm ² + 1 x 0.5 mm ²
External cable diameter Kablo dış çapı	12,80 mm ± 0.4 mm	17 mm ± 0.4 mm
Material surface of contacts Kontakt yüzeyi malzemesi	Silver Plated	Silver Plated
Operating temperature Çalışma sıcaklığı	-40 °C... + 125 °C	-40 °C... + 125 °C

ADR Certificated Complete Lighting Sets for Trailer (DORSET)
ADR Sertifikalı Komple Aydınlatma Seti (DORSET)

Report No. ADR1401001



Dorset for Trailer

D101Q137.ADR

ADR LIGHT SET

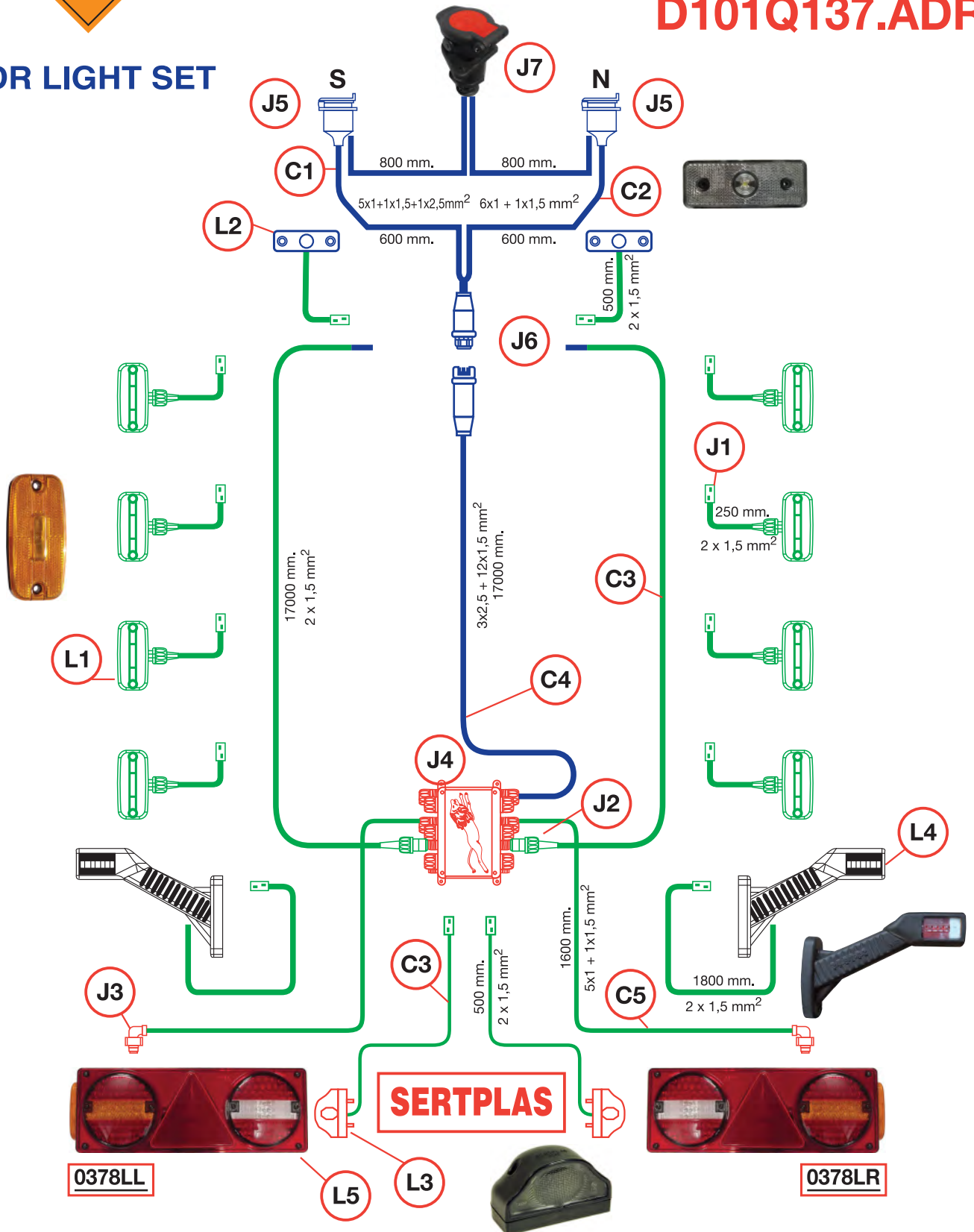

Complete Lighting Sets for Trailer (DORSET)
Komple Aydınlatma Seti (DORSET)

TRAIL-TECH

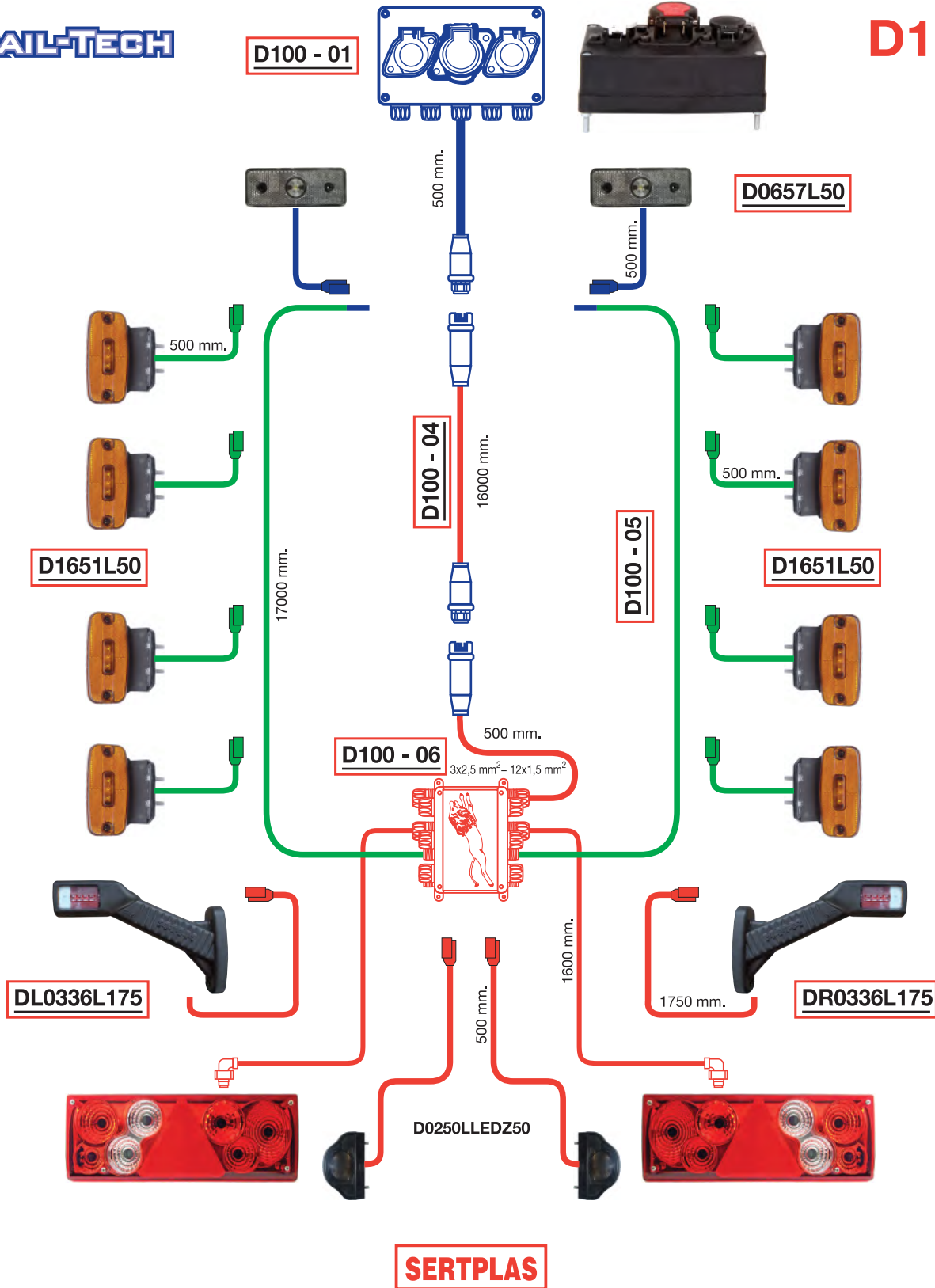

We would be pleased to supply DORSETs according to your special requirements.
(Özel isteklerinize uygun olarak dorset üretilebilir.)

Complete Lighting Sets for Trailer (DORSET)
Komple Aydınlatma Seti (DORSET)

TRAIL-TECH

D100Q9

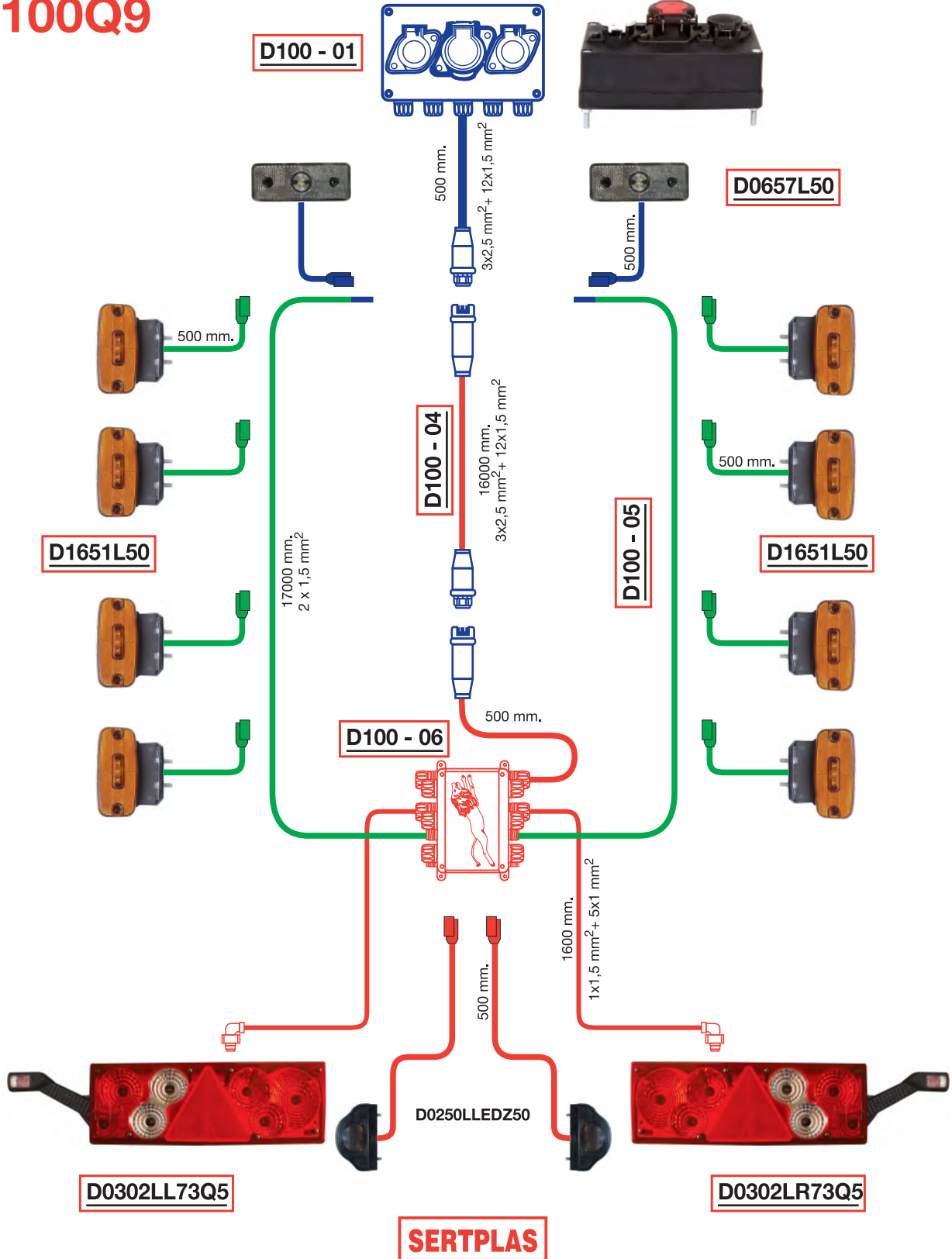

We would be pleased to supply DORSETs according to your special requirements.
(Özel isteklerinize uygun olarak dorset üretilebilir.)

Complete Lighting Sets for Trailer (DORSET)
Komple Aydınlatma Seti (DORSET)

TRAIL-TECH

D101Q1

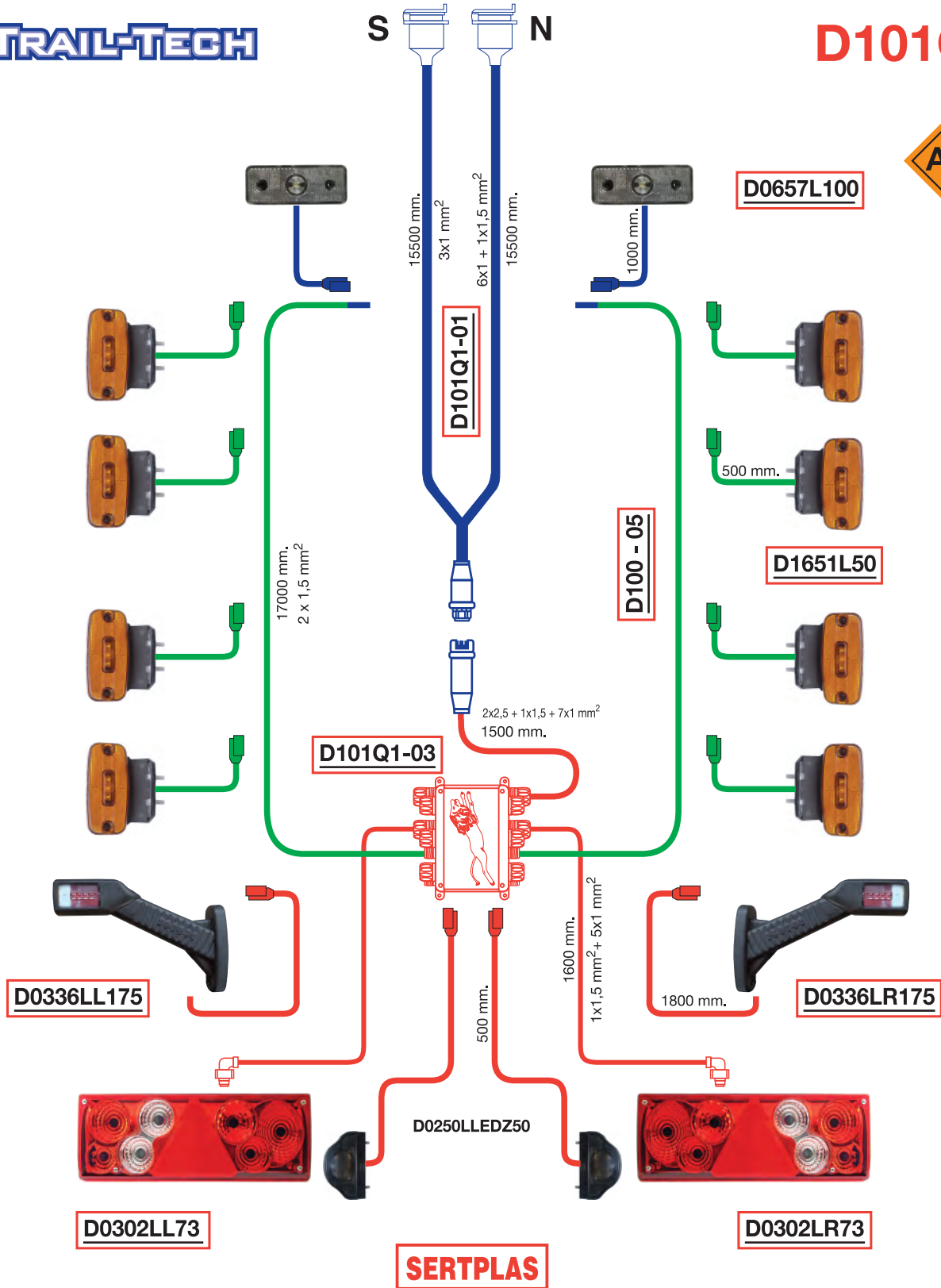

We would be pleased to supply DORSETs according to your special requirements.
(Özel isteklerinize uygun olarak dorset üretilebilir.)

Complete Lighting Sets for Trailer (DORSET)
Komple Aydınlatma Seti (DORSET)

D101Q112



TRAIL-TECH

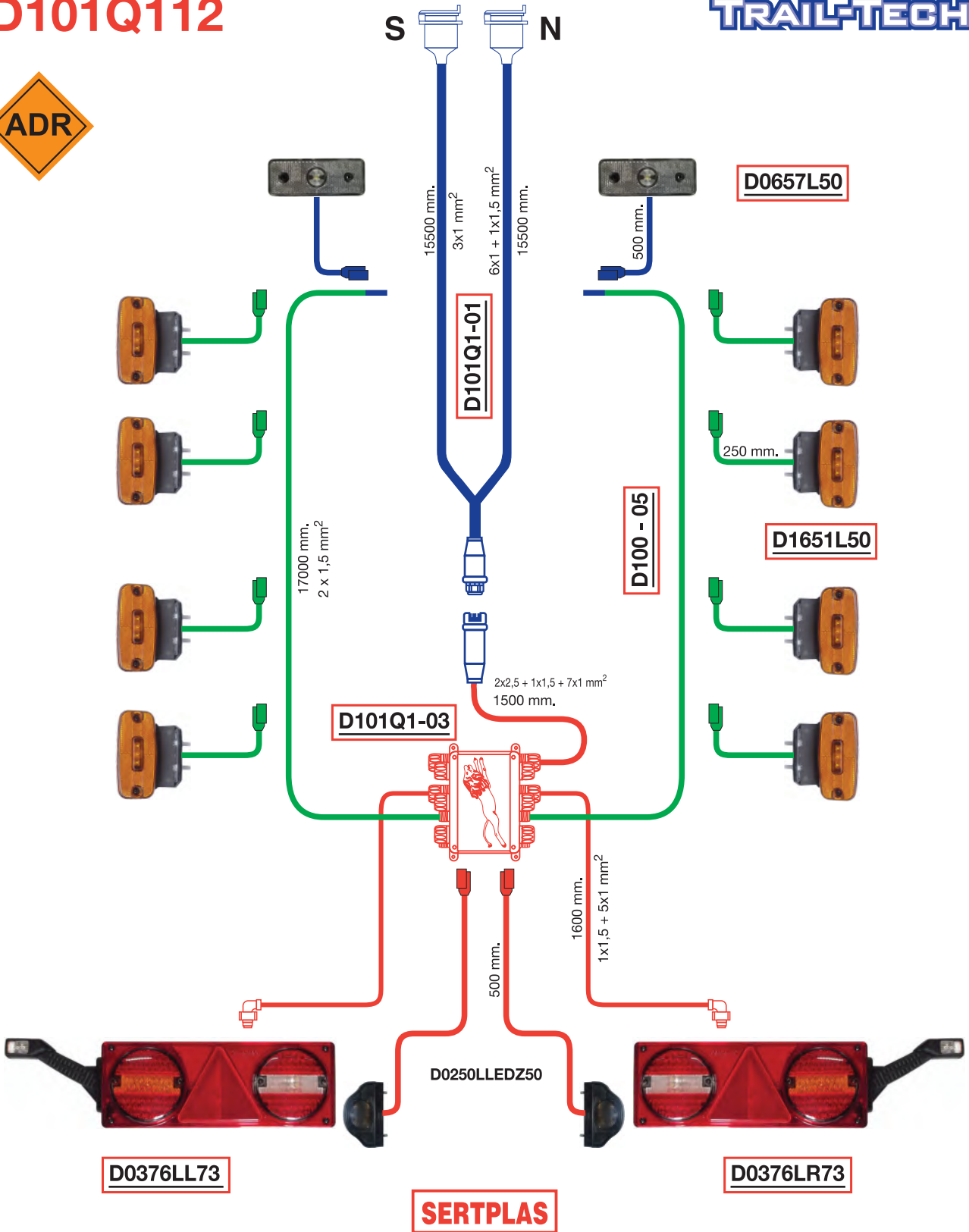

We would be pleased to supply DORSETs according to your special requirements.
(Özel isteklerinize uygun olarak dorset üretilebilir.)

Complete Lighting Sets for Trailer (DORSET)
Komple Aydınlatma Seti (DORSET)

TRAIL-TECH

D101Q118W

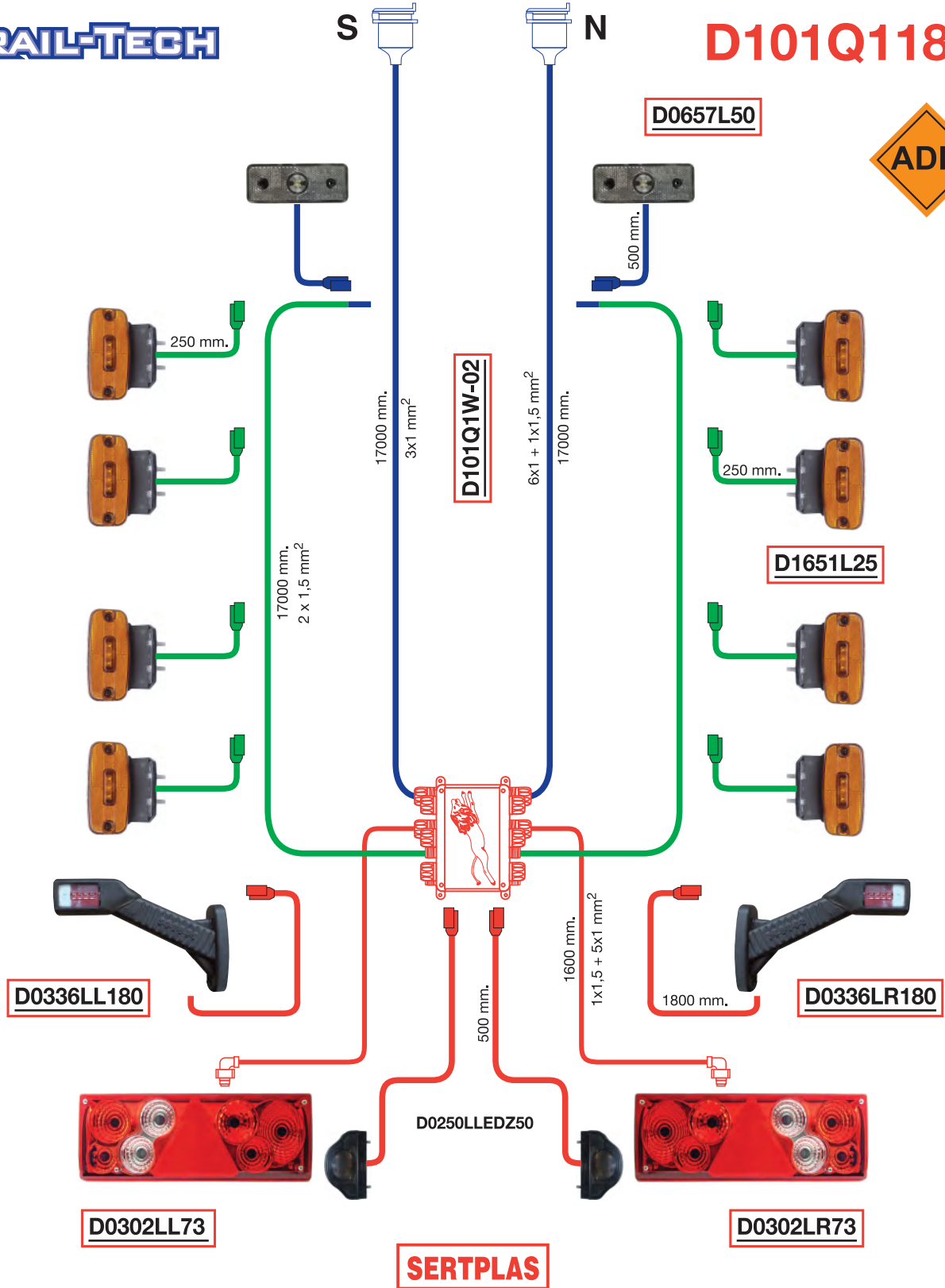

We would be pleased to supply DORSETs according to your special requirements.
(Özel isteklerinize uygun olarak dorset üretilebilir.)

Complete Lighting Sets for Trailer (DORSET)
Komple Aydınlatma Seti (DORSET)

D101Q1W



TRAIL-TECH

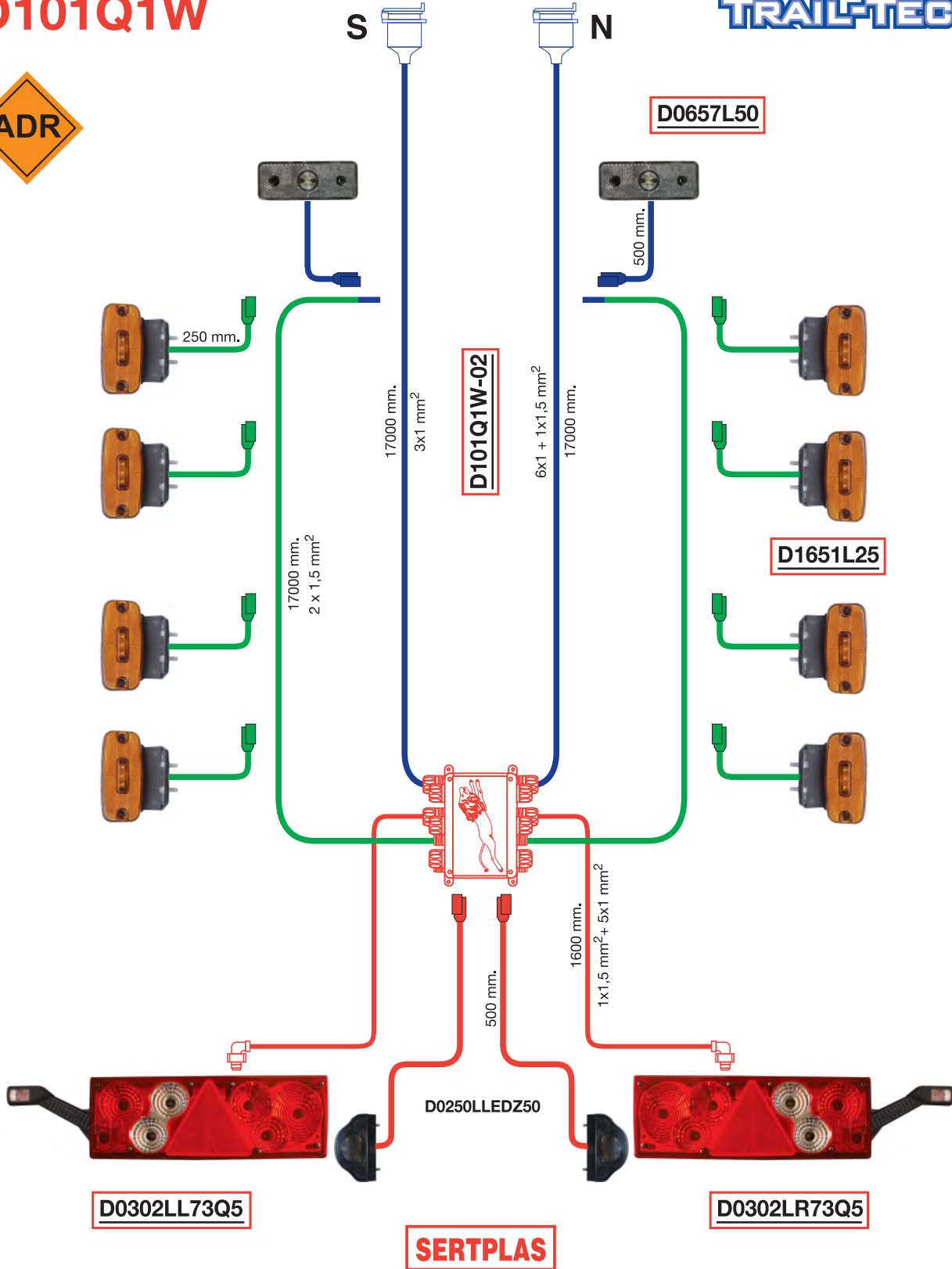

We would be pleased to supply DORSETs according to your special requirements.
(Özel isteklerinize uygun olarak dorset üretilebilir.)

Complete Lighting Sets for Trailer (DORSET)
Komple Aydınlatma Seti (DORSET)

TRAIL-TECH

D101Q7

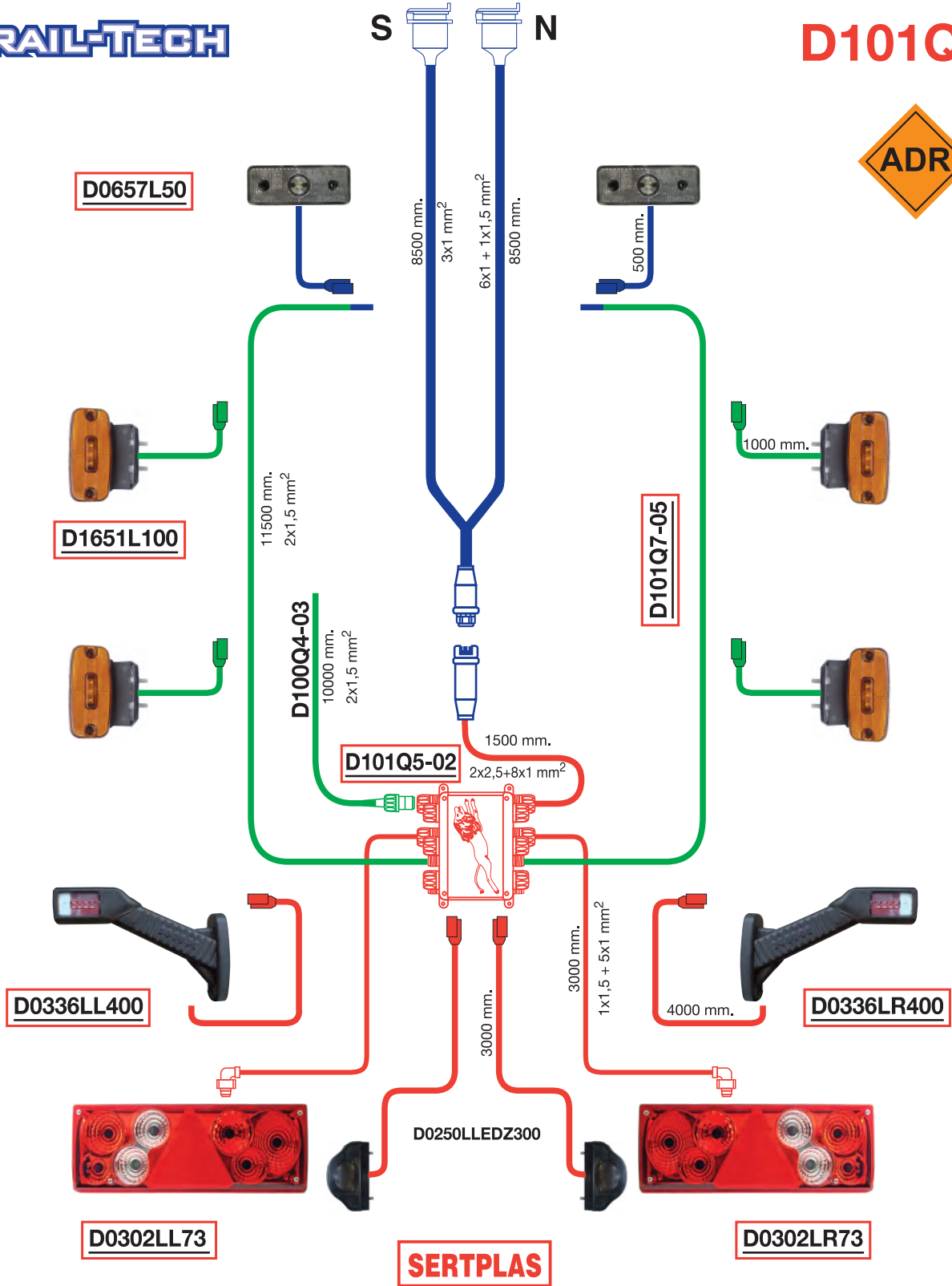

We would be pleased to supply DORSETs according to your special requirements.
(Özel isteklerinize uygun olarak dorset üretilebilir.)

Complete Lighting Sets for Trailer (DORSET)
Komple Aydınlatma Seti (DORSET)

D101Q7W



TRAIL-TECH

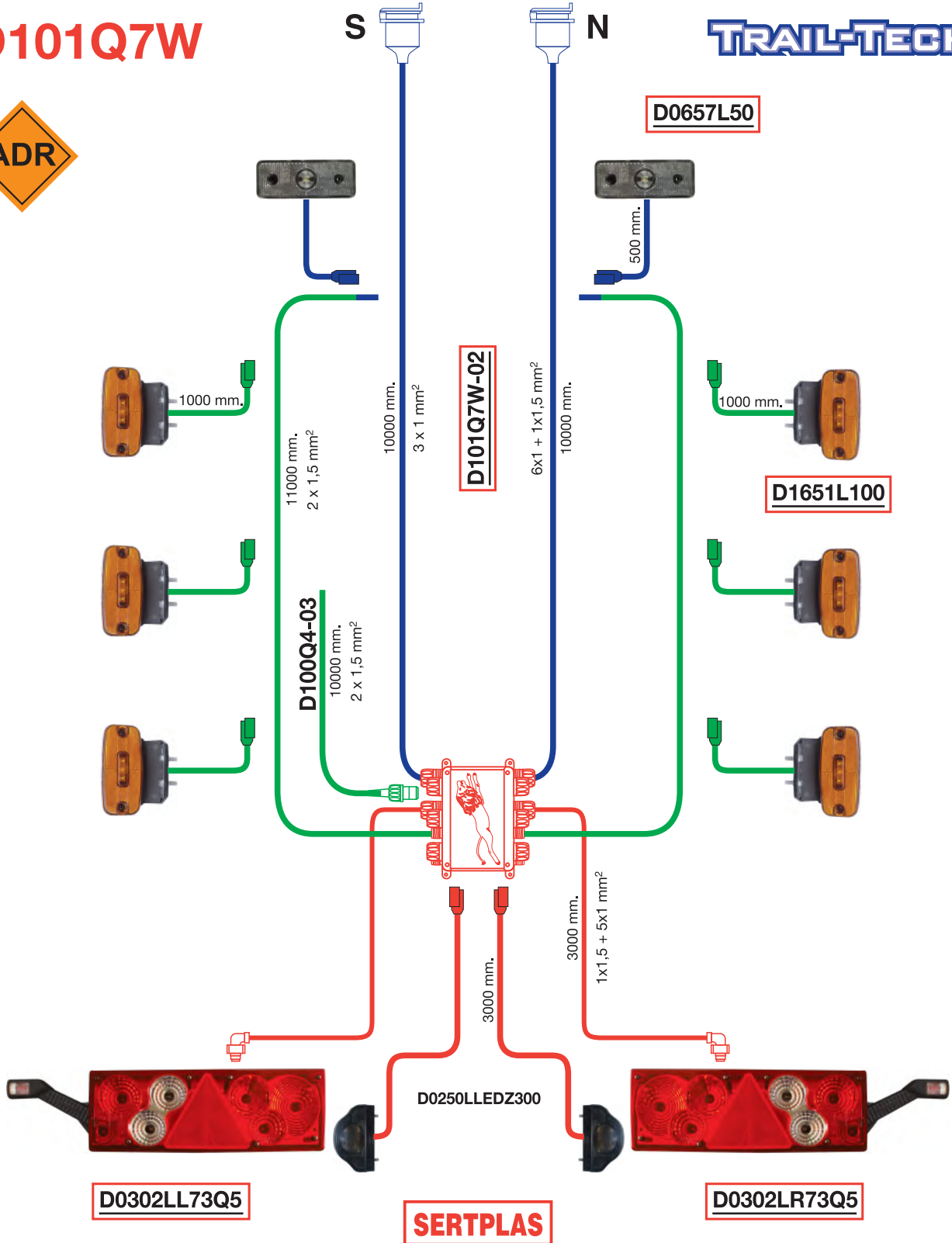

We would be pleased to supply DORSETs according to your special requirements.
(Özel isteklerinize uygun olarak dorset üretilebilir.)

Complete Lighting Sets for Trailer (DORSET)
Komple Aydınlatma Seti (DORSET)

TRAIL-TECH

D105

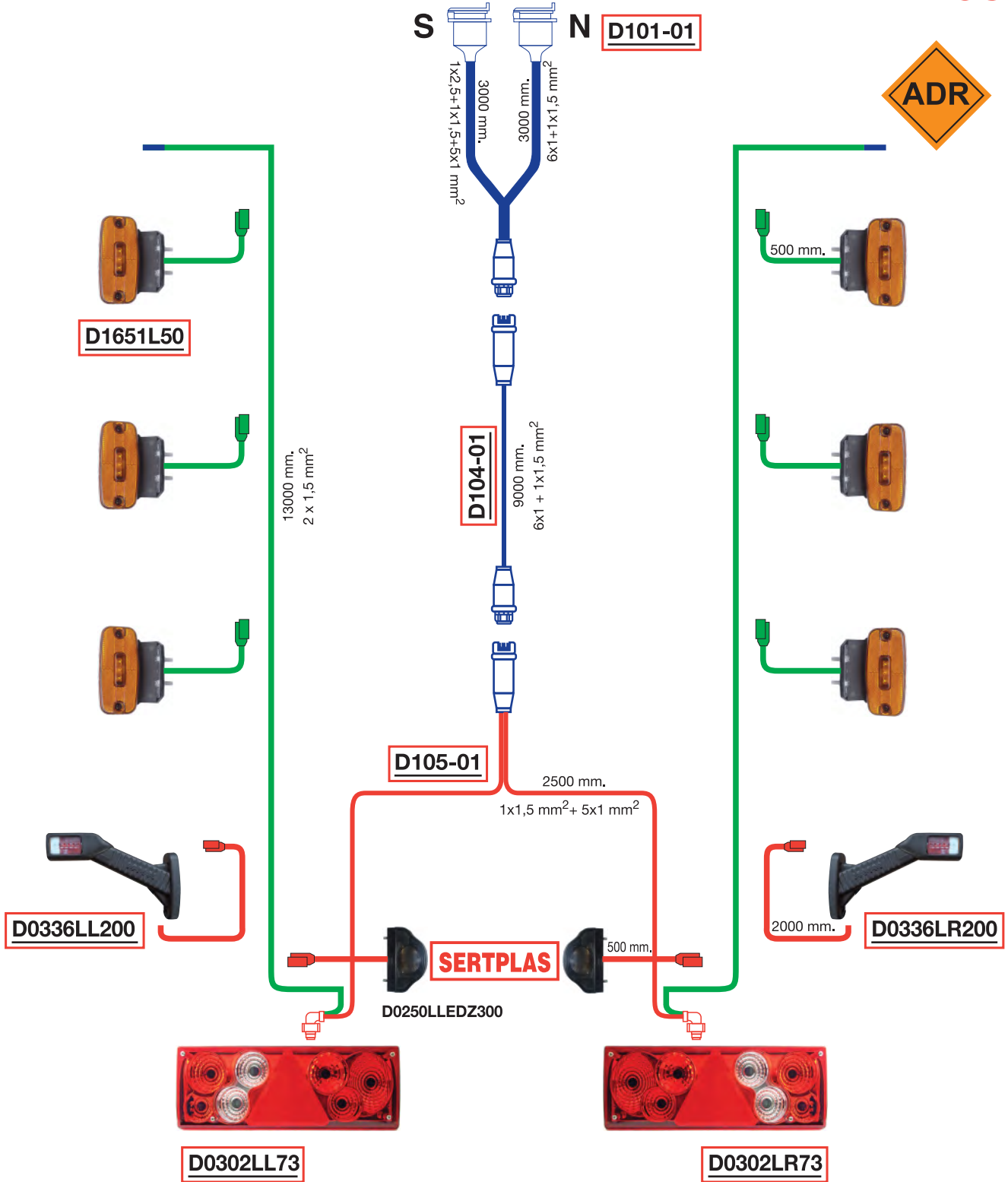

We would be pleased to supply DORSETs according to your special requirements.
(Özel isteklerinize uygun olarak dorset üretilebilir.)

Complete Lighting Sets for Trailer (DORSET)
Komple Aydınlatma Seti (DORSET)

D105Q116

TRAIL-TECH

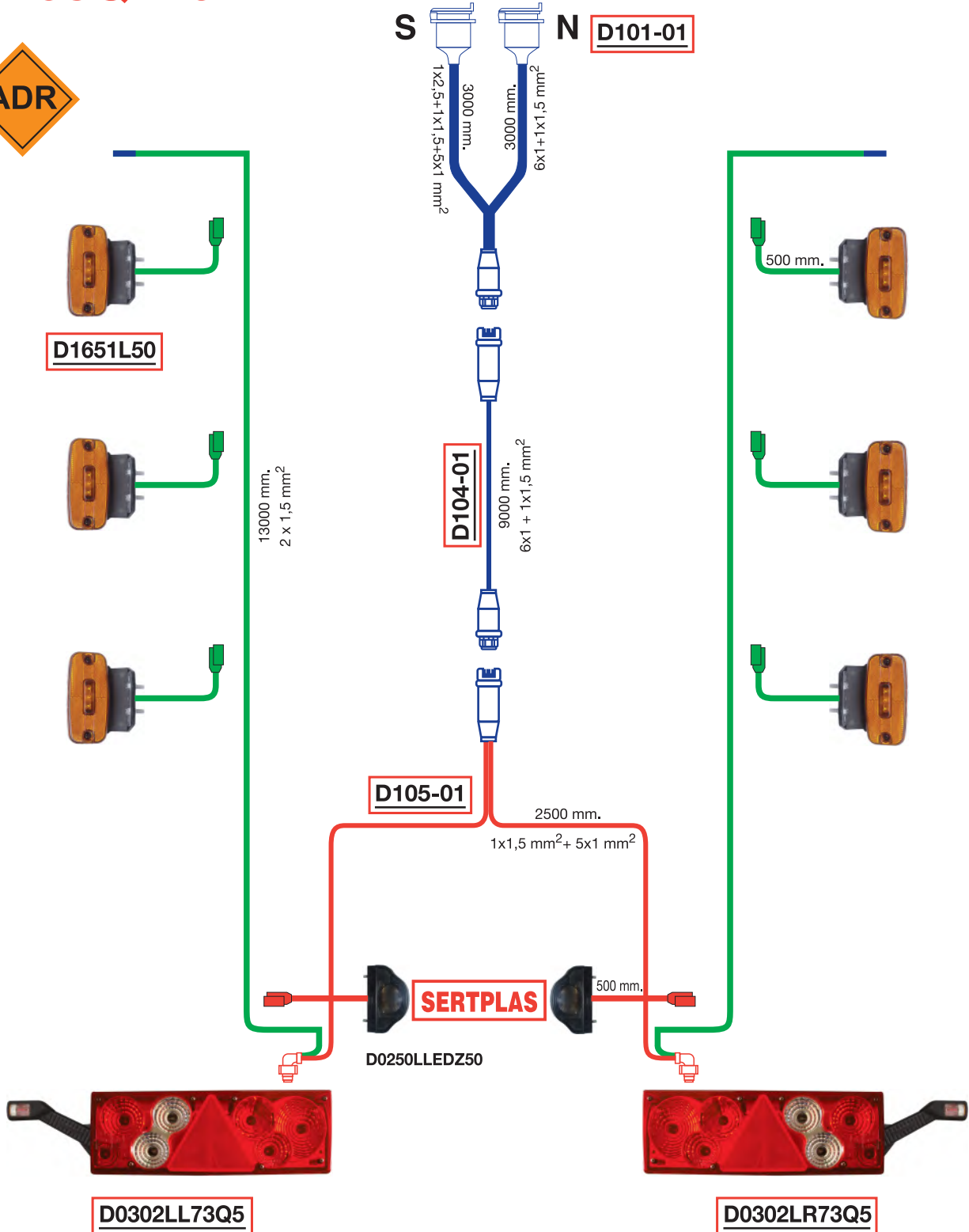

We would be pleased to supply DORSETs according to your special requirements.
(Özel isteklerinize uygun olarak dorset üretilebilir.)

Complete Lighting Sets for Trailer (DORSET)
Komple Aydınlatma Seti (DORSET)

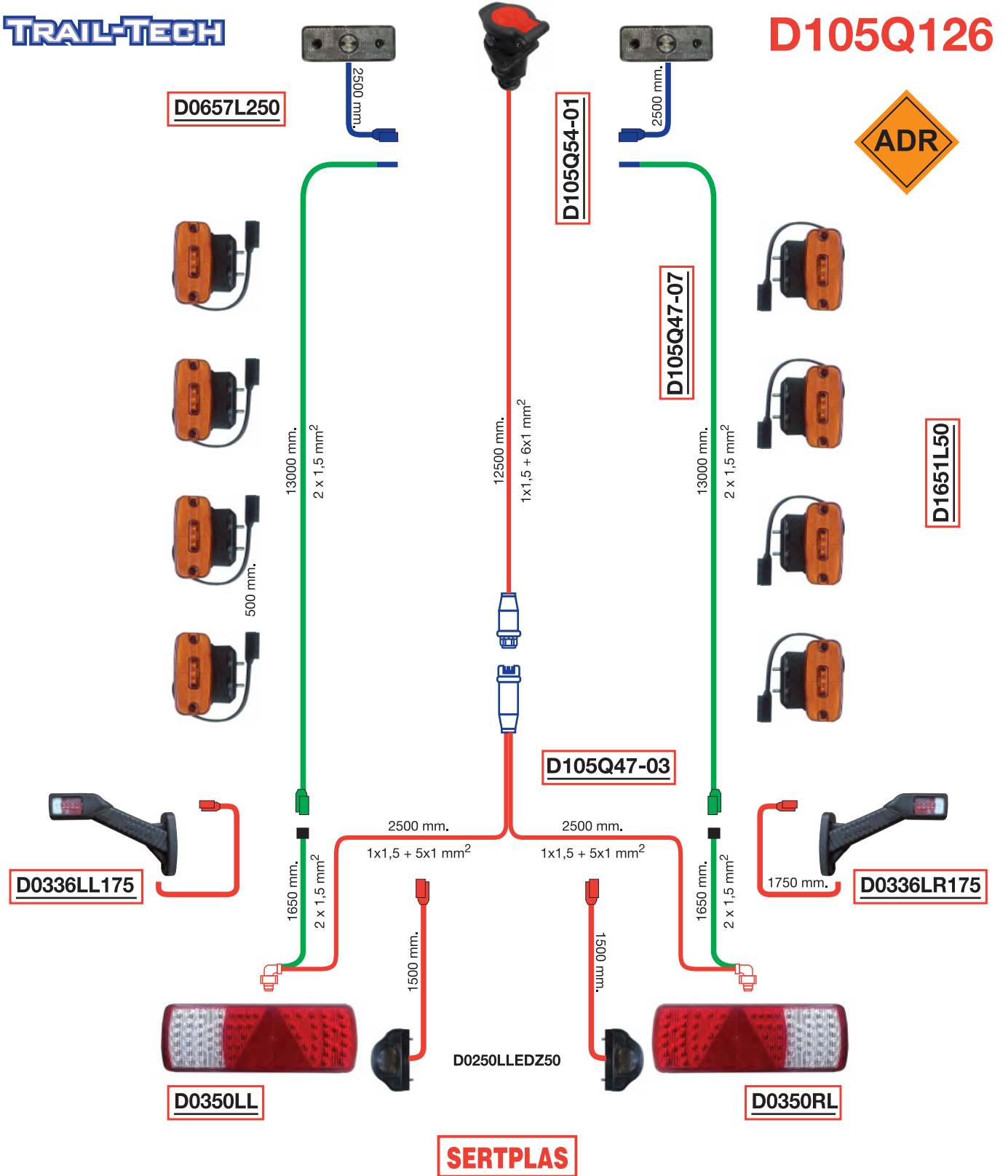

We would be pleased to supply DORSETs according to your special requirements.
(Özel isteklerinize uygun olarak dorset üretilebilir.)

Complete Lighting Sets for Trailer (DORSET)
Komple Aydınlatma Seti (DORSET)

D105Q122



TRAIL-TECH

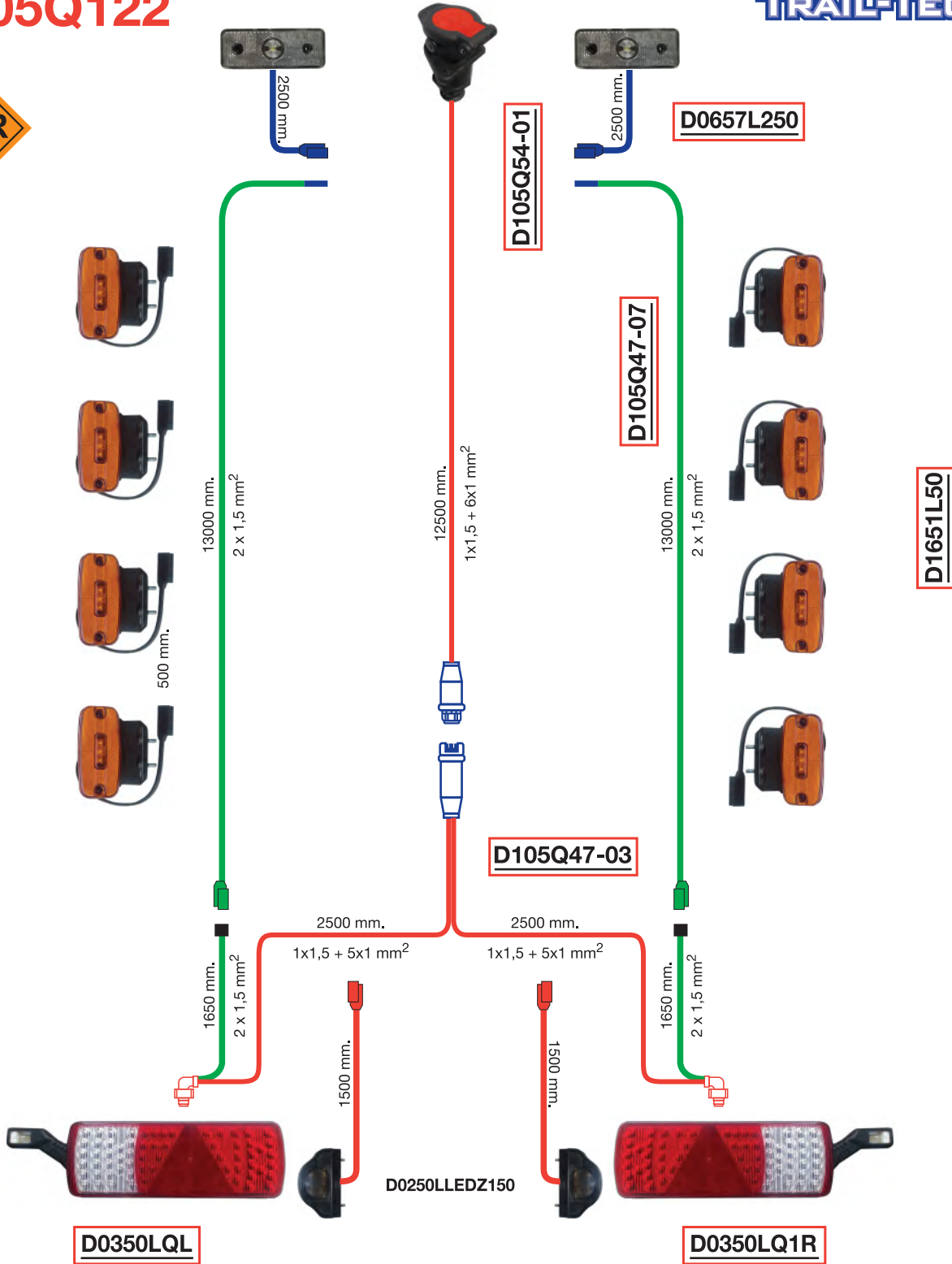

We would be pleased to supply DORSETs according to your special requirements.
(Özel isteklerinize uygun olarak dorset üretilebilir.)

Complete Lighting Sets for Trailer (DORSET) | Komple Aydınlatma Seti (DORSET)

TRAIL-TECH

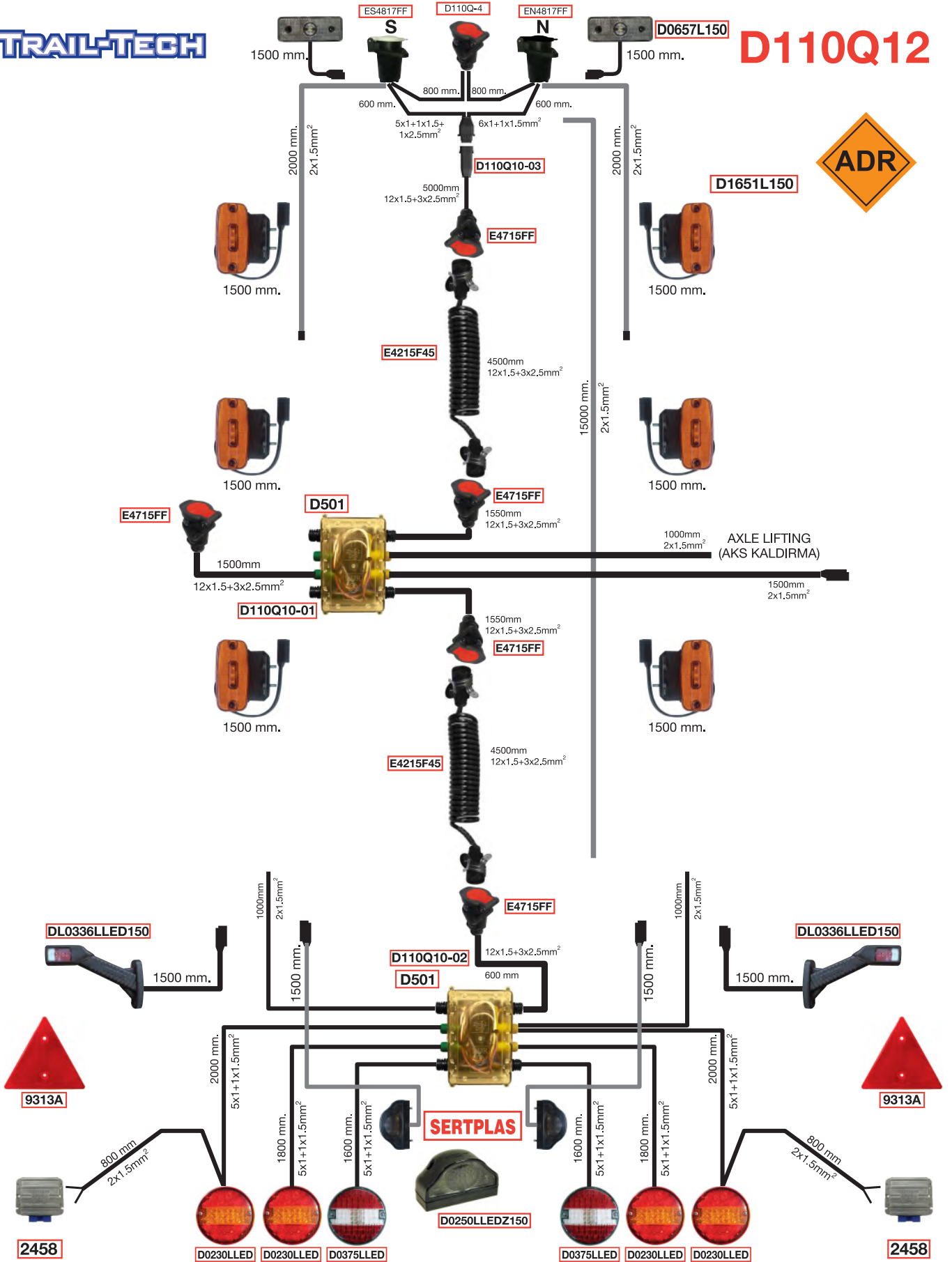

We would be pleased to supply DORSETs according to your special requirements.
(Özel isteklerinize uygun olarak dorset üretilir.)

Complete Lighting Sets for Trailer (DORSET) | Komple Aydınlatma Seti (DORSET)

TRAILER SET FOR 12V VEHICLES

D105Q170

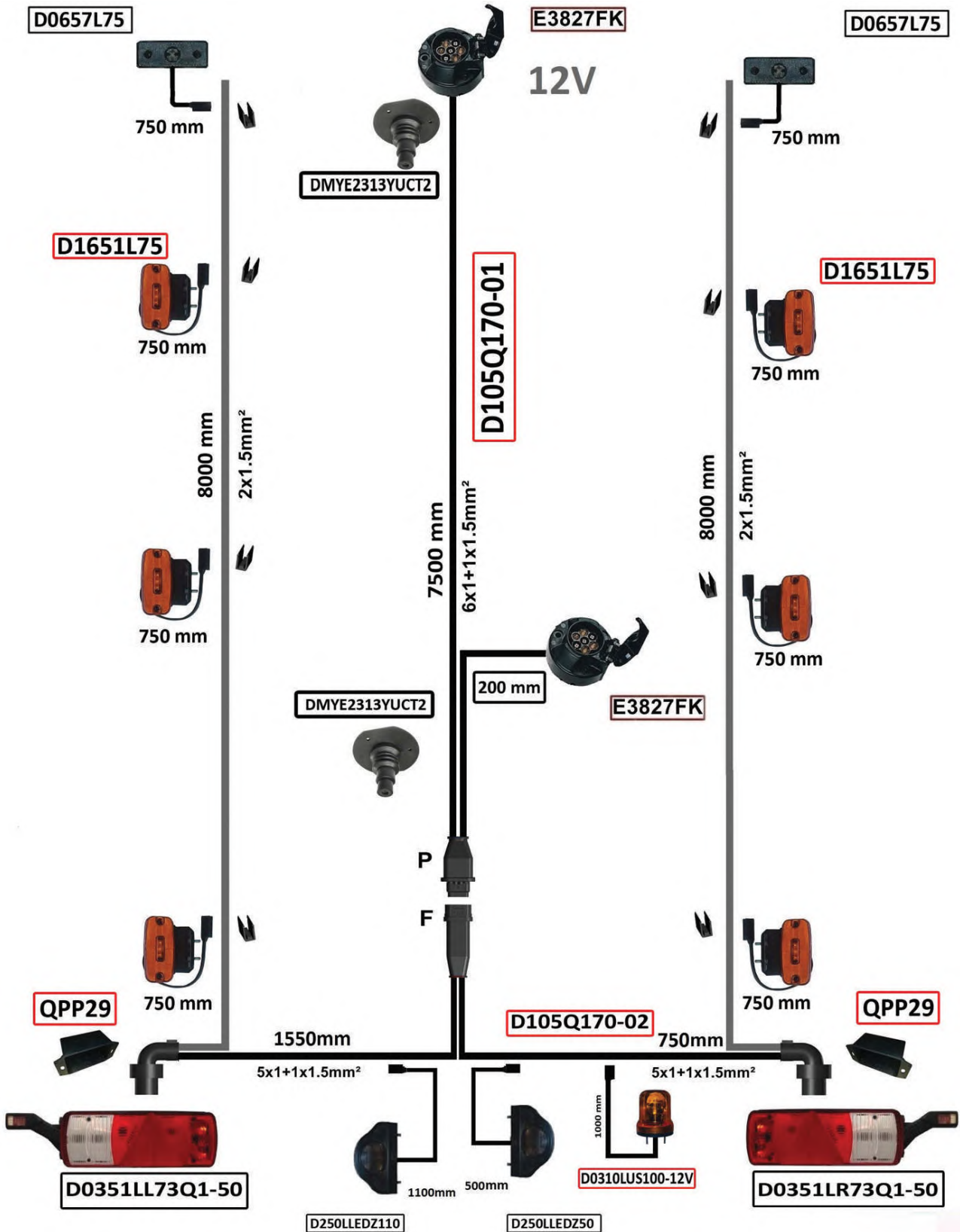

Socket Junction Box For Dorsets

N Type, S Type and 15 Poles Sockets Include



Without Cable

D200

Socket Junction Box For Dorsets

N Type, S Type and 15 Poles Sockets Include



Cable Length: 500 mm

D100-01

Junction Box With 15 Core Cable



Cable Length: 500 mm

D300



Junction Box With 15 Core Cable



Polycarbon Case
Cable Length: 500 mm

D301



Junction Box With 8 & 14 Port



Without Cable
D500.8
D500.14



D500

Junction Box With 8 & 14 Port Polycarbon Case



Without Cable
D501.8
D501.14



D501

Junction Box With AMP Socket



D107-03



Junction Box With AMP Socket

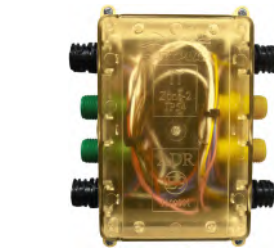

Polycarbon Case
D107-031



7 Core Electrical Cable with N/S Type Socket



Cable Length: 3000 mm
DSTY09.3M

D101-01



Junction Box With AMP Socket 2 Pieces AMP Type Socket Include



Cable Length:
15 Core 500 mm
7 Core 1600 mm (x2)

D100-06



Junction Box With AMP Socket 2 Pieces AMP Type Socket Include



Polycarbon Case
Cable Length:
15 Core 500 mm
7 Core 1600 mm (x2)

D100-061



2 Core Electrical Cable with S Type Socket 2 Poles Plug Include



Cable Length: 17000 mm
DSTY02.17M.FS01

D107-01



2 Core Electrical Cable with N Type Socket 2 Poles Plug Include



Cable Length: 17000 mm
DSTY01.17M.FS35

D107-02



Plug & Socket Set

D102-06

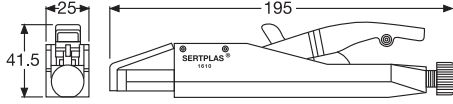

Order No: **DM1610**
Ek Çene Pensesi
Plier for Quick Connector
(For Lighting Set Use)

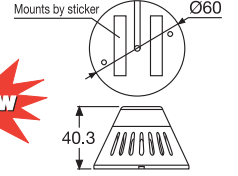

Order No: **2457**
Damper Uyarı Sistemi (24V)
Damper açık olduğunda ses ve ışık ile uyarı verir.
Tipper Warning System (24V)
Gives warn by sound and light when the tripper is opened.

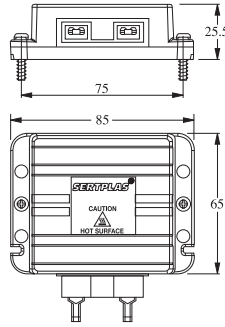

Order No: **2458**
24V LED Artza Giderici
24V LED Error Free Box

2 Core Square Sheathed Cables Kit (Right / Left)



D100-05

Cable Length: 17000 mm

DSTY20.17MS/Y

Tail Lamp Cables Kit (Austrian Plug type) (Right/Left 2500 mm x 2)
2 Core Square Sheathed Cable Include 500 mm x 2)



D104-03

DSTY12.250.250

15 Poles Electrical Cable For Dorsets

Electrical Cable For Tail Lamps
(Austrian Plug type and Female Flat Terminal Connection)



Cable Length: 1600 mm

DSTY14.160S(Y)

D400R (Right)

D400L (Left)

D100-04

Cable Length: 16000 mm **DSTY10.15.16M**

Tail Lamp Electrical Cable (With AMP Plug Type)



D107-06

Cable Length: 2500 mm

DSTY22.250

CABLES (KABLÖLAR)	SIZE (KESİT) (mm ²)	ORDER NO (SİPARİŞ NO)
	(3x2,5 mm ² +12x1,5 mm ²)	QKL15DISO
	(2x2,5mm ² +8x1mm ²)	QKL10D732AQ
	(2x2,5mm ² +6x1mm ²)	QKL8D225A
	(2x2,5mm ² +5x1mm ²)	QKL7D225N
	(2x2,5mm ² +4x1mm ²)	QKL6D225N
	(1x2,5mm ² +7x1,5mm ²)	QKL8D125A15
	(1x2,5mm ² +6x1mm ²)	QKL7D125A
	(2x2,5mm ² +3x1mm ²)	QKL5D215S
	(1x1,5mm ² +6x1mm ²)	QKL7D115N
	(1x2,5mm ² +1x1,5mm ² +5x1mm ²)	QKL7D125S
	1x1,5mm ² +5x1mm ² (Right)	QKL6D115R
	1x1,5mm ² +5x1mm ² (Left)	QKL6D115L
	2x1mm ² (Rectangular)	QKL/210KR
	2x1,5mm ² (Rectangular)	QKL/215KR
	2x1,5mm ² (Round)	QKL2D73S
	3x1mm ² (For Power Supply)	QKL3D743S
	3x1mm ² (For Lift)	QKL3D732S

Ref.Digits at the end denotes the length of the cable in cm.
Kod sonundaki haneler kablo uzunluğu içindir (cm).



D1651L50

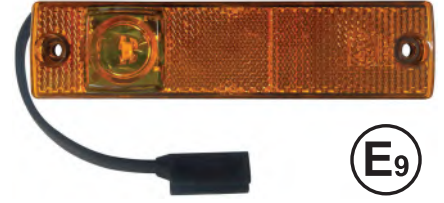

D1381LUS50



D1652L50

5 LED



D1309L50



D0260L50

1 LED



D1654L50



D1656L50

4 LED



D0653L50



D0657L50



D0250LZ50 With Bulb
D0250LLEDZ50 With LED



with LED

D0336LR175 (Right)
D0336LL175 (Left)



with bulb
D0084LR175 (Right)
D0084LL175 (Left)

with LED
D0084LLEDR175 (Right)
D0084LLEDL175 (Left)



LED Trailer Rear Lamp

0010

LED Dorse Arka Stop Lambası

Functions Stop, Side Marker, Position, Reflector, Rear Fog, Indicator, Front Position, Reverse

Fonksiyonlar Stop, Yan Marker, Pozisyon, Reflektör, Arka Sis, Sinyal, Ön Pozisyon, Geri Vites

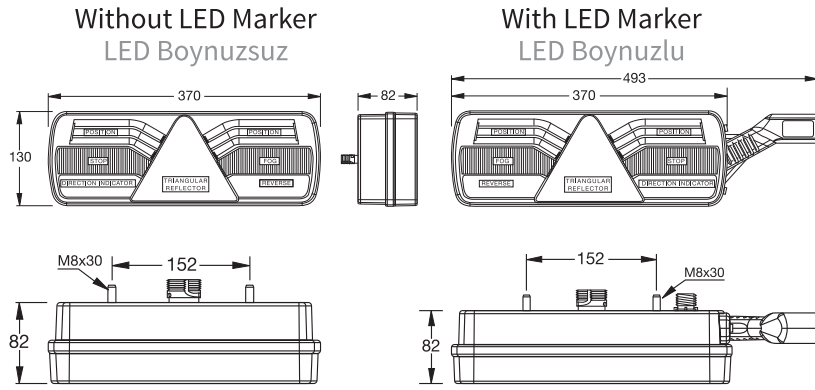

A Light Control Gear kit is integrated to product against to Indicator Failures. This Light Control Gear (LCG) enables truck&trailers with a non LED conform electrical system to operate LED lamps by adjust the electrical properties.

Order Number | Sipariş Kodu



0010LL

0010LR

0010LQ1L

0010LQ1R



15 pcs Adet
40,5x58x42,5 cm
~21,2 kg



15 pcs Adet
40,5x58x52 cm
~24,2 kg

Fastening Bolts | Bağlantı Civataları

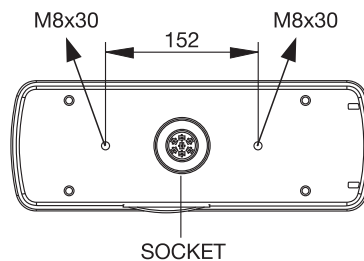

0350

LED Trailer Rear Lamp

LED Dorse Arka Stop Lambası



Functions Stop, Side Marker, Position, Reflector, Rear Fog, Indicator, Front Position, Reverse

Fonksiyonlar Stop, Yan Marker, Pozisyon, Reflektör, Arka Sis, Sinyal, Ön Pozisyon, Geri Vites



A Light Control Gear kit is integrated to product against to Indicator Failures. This Light Control Gear (LCG) enables truck&trailers with a non LED conform electrical system to operate LED lamps by adjust the electrical properties.

Without LED Marker
LED Boynuzsuz

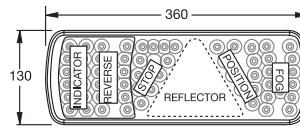

With LED Marker
LED Boynuzlu

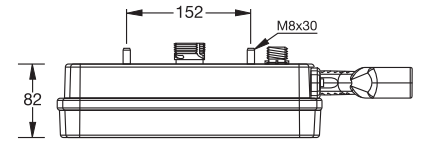
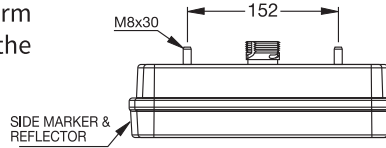
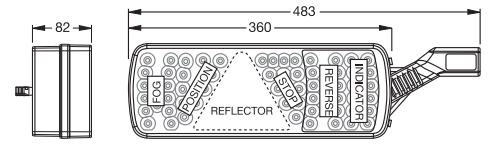

Order Number | Sipariş Kodu



Left
Sol

Right
Sağ

Left with LED Marker
LED Boynuzlu Sol

Right with LED Marker
LED Boynuzlu Sağ

0350LL

0350LR

0350LQ1L

0350LQ1R



20 pcs Adet
41x58x53 cm
~27,7 kg



12 pcs Adet
41x48x46 cm
~19 kg

Fastening Bolts | Bağlantı Civataları

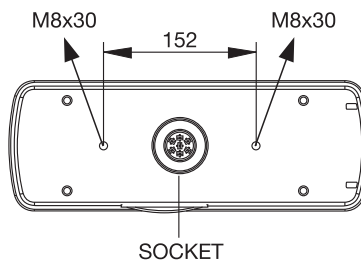

Trailer Rear Lamp

0351

Dorse Arka Stop Lambası

Functions Reverse, Stop, Side Marker, Position, Reflector, Rear Fog, Indicator, Num. Plate, Front Position, End Outline Marker, Rear Position

Fonksiyonlar Geri Vites, Stop, Yan Marker, Pozisyon, Reflektör, Arka Sis, Sinyal, Plaka, Ön Pozisyon, Uç Yan Marker, Arka Pozisyon



Without Marker
Boynuzsuz

With Marker
Boynuzlu

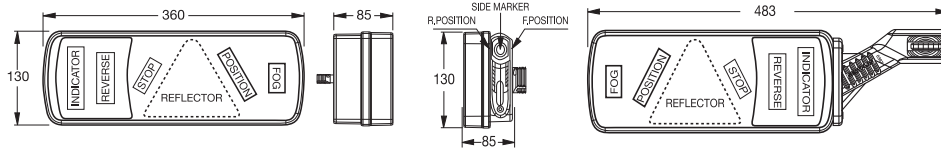

Order Number | Sipariş Kodu



Left
Sol

Right
Sağ

Left with Marker
LED Boynuzlu Sol

Right with Marker
LED Boynuzlu Sağ

0351LL

0351LR

0351LL73Q1

0351LR73Q1



20 pcs Adet
41x58x53 cm
~27,7 kg



12 pcs Adet
41x48x46 cm
~19 kg

Only Lens | Sadece Cam



0351CL

0351CR



50 pcs Adet
51x60,5x46,5 cm
~17,6 kg

Fastening Bolts | Bağlantı Civataları

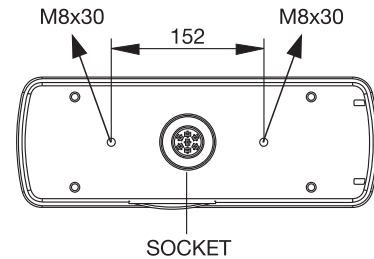

0302

Trailer Rear Lamp

Dorse Arka Stop Lambası



Functions Reverse, End-Outline Marker, Stop, Side Marker, Position, Reflector, Rear Fog, Indicator, Num. Plate

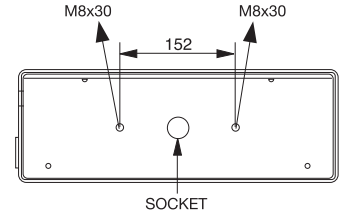
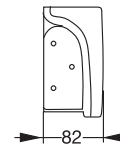
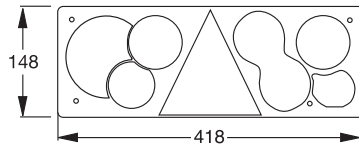

Fonksiyonlar Geri Vites, Uç Yan Marker, Stop, Yan Marker, Pozisyon, Reflektör, Sinyal, Arka Sis, Plaka

Fastening Bolts | Bağlantı Civataları



Order Number | Sipariş Kodu



Left Sol	Socket Type Bağlantı Tipi	Right Sağ	
0302LL61	With Gromet & Cable (30 cm) 	0302LR61	13 pcs Adet 40x59x43 cm ~20,6 kg
0302LL73	Austrian Blade Socket 	0302LR73	13 pcs Adet 40x59x43 cm ~20,6 kg

Only Lens | Sadece Cam



0302CL

0302CR



50 pcs Adet
49,5x58x58 cm
~20,9 kg

Trailer Rear Lamp

Dorse Arka Stop Lambası

0302

Functions Reverse, End Outline Marker, Stop, Side Marker, Position, Reflector, Rear Fog, Indicator, Num. Plate, Front Position, Rear Position

Fonksiyonlar Geri Vites, Uç Yan Marker, Stop, Yan Marker, Pozisyon, Reflektör, Sinyal, Arka Sis, Plaka, Ön Pozisyon, Arka Pozisyon

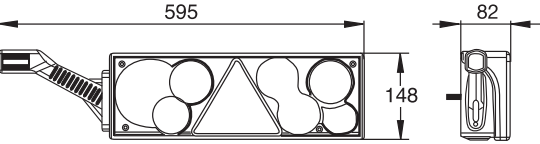

0302LL73Q5

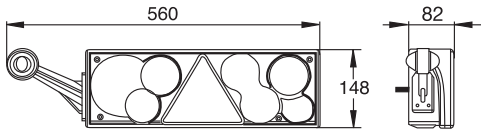

0302LL73Q1

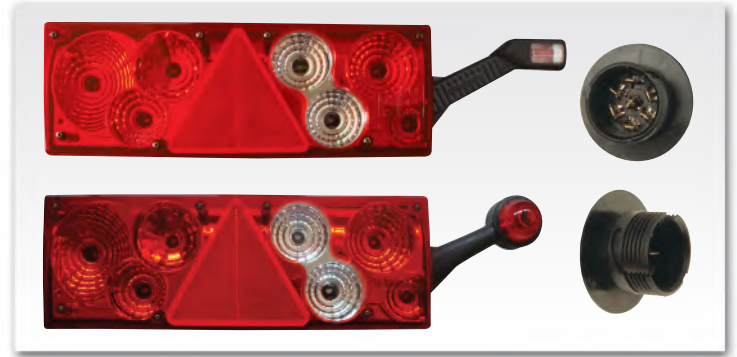

Order Number | Sipariş Kodu



Left
Sol



Right
Sağ



Left
Sol



Right
Sağ

0302LL73Q5

0302LR73Q5

0302LL73Q1

0302LR73Q1



12 pcs Adet
51x61x47cm
~20,7 kg



12 pcs Adet
51x61x47cm
~17 kg

Only Lens | Sadece Cam



0302CL



0302CR



50 pcs Adet
49,5x58x58 cm
~20,9 kg

Fastening Bolts | Bağlantı Civataları

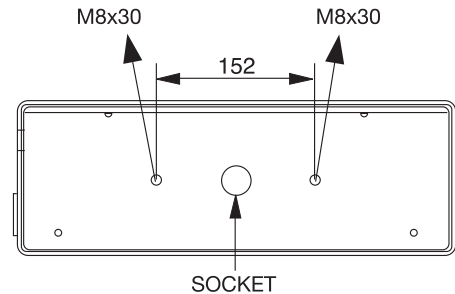

0376-0378

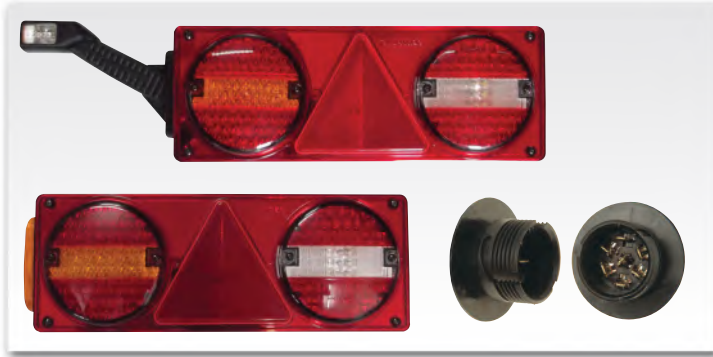

A Light Control Gear kit is integrated to product against to Indicator Failures. This Light Control Gear (LCG) enables truck&trailers with a non LED conform electrical system to operate LED lamps by adjust the electrical properties.

LED Trailer Rear Lamp

LED Dorse Arka Stop Lambası

Functions	Stop, Side Marker, Position, Reflector, Rear Fog, Indicator, Reverse, Front Position
Fonksiyonlar	Stop, Yan Marker, Pozisyon, Reflektör, Arka Sis, Sinyal, Geri Vites, Ön Pozisyon

With LED Side Lamp
LED Yan Lambalı

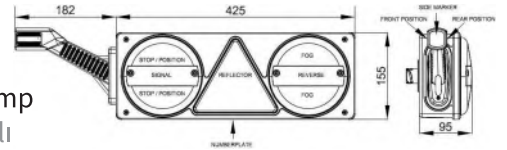

Without LED Side Lamp
LED Yan Lambasız

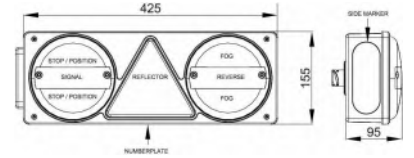

Order Number | Sipariş Kodu



Left
Sol

Right
Sağ

Left
Sol

Right
Sağ

0376LL73

0376LR73

0378LL73

0378LR73



12 pcs Adet
51x60,5x46,5 cm
~23,8 kg



16 pcs Adet
41x80x47 cm
~18,6 kg

Fastening Bolts | Bağlantı Civataları

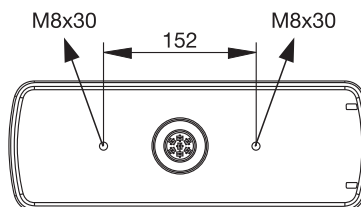

Trailer Rear Lamp

0030

Dorse Arka Stop Lambası

Functions Reverse, End-Outline Marker, Stop, Side Marker, Position, Reflector, Rear Fog, Indicator, Num. Plate

Fonksiyonlar Geri Vites, Uç Yan Marker, Stop, Yan Marker, Pozisyon, Reflektör, Sinyal, Arka Sis, Plaka

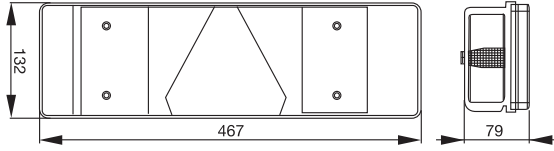

Order Number | Sipariş Kodu

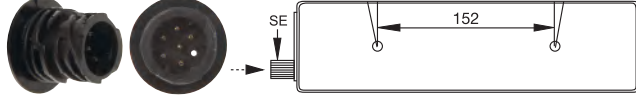
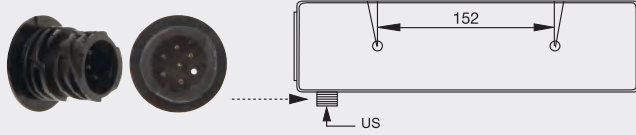
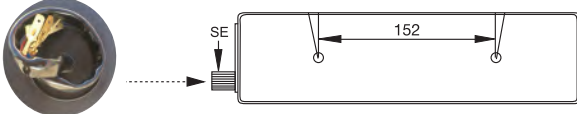
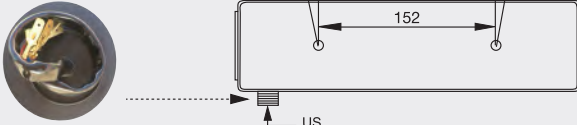

Left Sol	Socket Type Bağlantı Tipi	Right Sağ	
0030LL742T SE Type AMP		0030LR742T	14 pcs Adet 29x82,5x49,5 cm ~17,6 kg
0030LL741T US Type AMP		0030LR741T	14 pcs Adet 29x82,5x49,5 cm ~17,6 kg
0030LL612T SE Gromet and Cable (30cm)		0030LR612T	14 pcs Adet 29x82,5x49,5 cm ~17,6 kg
0030LL611T US Gromet and Cable (30 cm)		0030LR611T	14 pcs Adet 29x82,5x49,5 cm ~17,6 kg

Only Lens | Sadece Cam



0030CLT

0030CRT



30 pcs Adet
29x41x51 cm
~10,8 kg

Fastening Bolts | Bağlantı Civataları

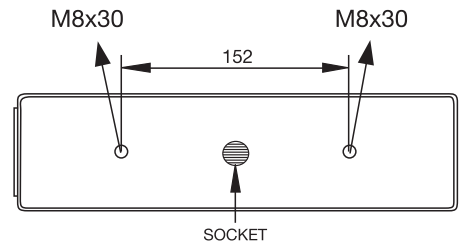

0030

Trailer Rear Lamp

Dorse Arka Stop Lambası



Functions Reverse, End-Outline Marker, Stop, Side Marker, Position, Reflector, Rear Fog, Indicator, Num. Plate

Fonksiyonlar Geri Vites, Uç Yan Marker, Stop, Yan Marker, Pozisyon, Reflektör, Sinyal, Arka Sis, Plaka

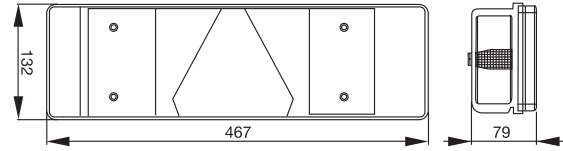

Order Number | Sipariş Kodu



Left Sol	Socket Type Bağlantı Tipi	Right Sağ	
0030LL51T	Universal Gromet with Cable (60 cm)	0030LR51T	14 pcs Adet 29x82,5x49,5 cm ~18,3 kg
0030LL61T	With Gromet & Cable (30 cm)	0030LR61T	14 pcs Adet 29x82,5x49,5 cm ~18 kg
0030LL72T	Schlemmer Socket	0030LR72T	14 pcs Adet 29x82,5x49,5 cm ~18,4 kg
0030LL73T	Austrian Blade Socket	0030LR73T	14 pcs Adet 29x82,5x49,5 cm ~18 kg
0030LL74T	AMP Socket	0030LR74T	14 pcs Adet 29x82,5x49,5 cm ~17,4 kg

Only Lens | Sadece Cam



0030CLT

0030CRT



30 pcs Adet
31x40x46,5 cm
~10,1 kg

Fastening Bolts | Bağlantı Civataları

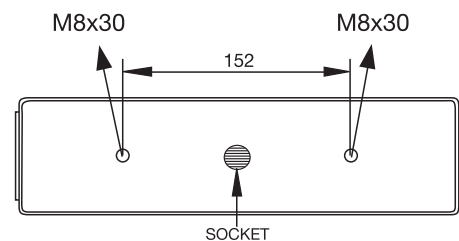

Trailer Rear Lamp

0023

Dorse Arka Stop Lambası

Functions Reverse, End-Outline Marker, Stop, Side Marker, Position, Reflector, Rear Fog, Indicator, Num. Plate

Fonksiyonlar Geri Vites, Uç Yan Marker, Stop, Yan Marker, Pozisyon, Reflektör, Sinyal, Arka Sis, Plaka

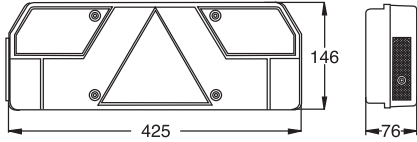

Order Number | Sipariş Kodu



Left Sol	Socket Type Bağlantı Tipi	Right Sağ	
0023LL50	Universal Gromet	0023LR50	14 pcs Adet 37,5x63x44 cm ~19,4 kg
0023LL51	Universal Gromet with Cable (60 cm)	0023LR51	14 pcs Adet 37,5x63x44 cm ~19,4 kg
0023LL72	Schlemmer Socket	0023LR72	14 pcs Adet 37,5x63x44 cm ~21,9 kg
0023LL73	Austrian Blade Socket	0023LR73	14 pcs Adet 37,5x63x44 cm ~24,7 kg
0023LL74	AMP Socket	0023LR74	14 pcs Adet 37,5x63x44 cm ~24,6 kg

Only Lens | Sadece Cam



0023CL

0023CR



16 pcs Adet
31x40x46,5 cm
~6,7 kg

Fastening Bolts | Bağlantı Civataları

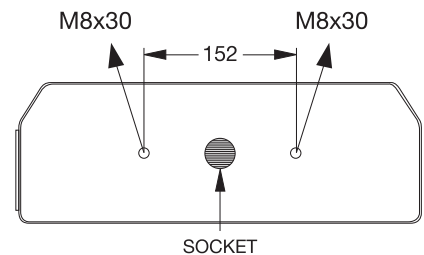

0023

Trailer Rear Lamp

Dorse Arka Stop Lambası



Functions Reverse, End-Outline Marker, Stop, Side Marker, Position, Reflector, Rear Fog, Indicator, Num. Plate

Fonksiyonlar Geri Vites, Uç Yan Marker, Stop, Yan Marker, Pozisyon, Reflektör, Sinyal, Arka Sis, Plaka

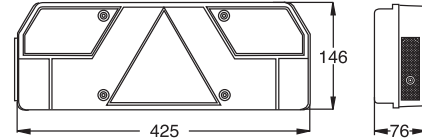

Order Number | Sipariş Kodu



Left Sol	Socket Type Bağlantı Tipi	Right Sağ	
0023DLL50	Universal Gromet	0023DLR50	14 pcs Adet 37,5x63x44 cm ~19,1 kg
0023DLL51	Universal Gromet with Cable (60 cm)	0023DLR51	14 pcs Adet 37,5x63x44 cm ~20,8 kg
0023DLL72	Schlemmer Socket	0023DLR72	14 pcs Adet 37,5x63x44 cm ~19,3 kg
0023DLL73	Austrian Blade Socket	0023DLR73	14 pcs Adet 37,5x63x44 cm ~19,1 kg
0023DLL74	AMP Socket	0023DLR74	14 pcs Adet 37,5x63x44 cm ~19,3 kg

Only Lens | Sadece Cam



0023CL

0023CR



16 pcs Adet
31x40x46,5 cm
~6,7 kg

Fastening Bolts | Bağlantı Civataları

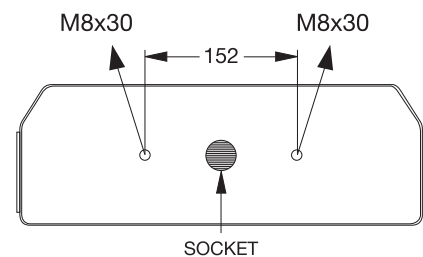

Trailer Rear Lamp

0023

Dorse Arka Stop Lambası

Functions Reverse, End-Outline Marker, Stop, Side Marker, Position, Reflector, Rear Fog, Indicator, Num. Plate

Fonksiyonlar Geri Vites, Uç Yan Marker, Stop, Yan Marker, Pozisyon, Reflektör, Sinyal, Arka Sis, Plaka

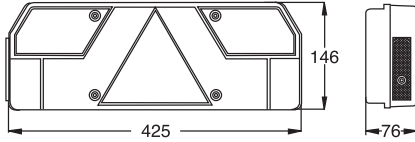

Order Number | Sipariş Kodu



Left Sol	Socket Type Bağlantı Tipi	Right Sağ	
0023LL50Q	Universal Gromet	0023LR50Q	14 pcs Adet 37,5x63x44 cm ~19,4 kg
0023LL51Q	Universal Gromet with Cable (60 cm)	0023LR51Q	14 pcs Adet 37,5x63x44 cm ~19,4 kg
0023LL72Q	Schlemmer Socket	0023LR72Q	14 pcs Adet 37,5x63x44 cm ~21,9 kg
0023LL73Q	Austrian Blade Socket	0023LR73Q	14 pcs Adet 37,5x63x44 cm ~24,7 kg
0023LL74Q	AMP Socket	0023LR74Q	14 pcs Adet 37,5x63x44 cm ~24,6 kg

Only Lens | Sadece Cam



0023CLQ

0023CRQ



16 pcs Adet
31x40x46,5 cm
~6,7 kg

Fastening Bolts | Bağlantı Civataları

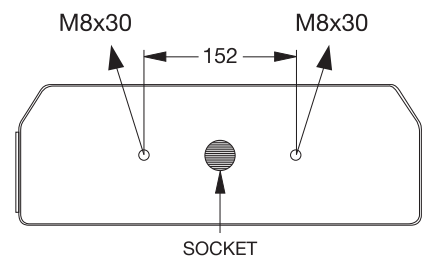

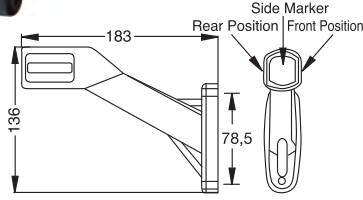

12V /24V



Side Marker with LED
Ledli Yan İşaret Lambası

Order Number | Sipariş Kodu

Left | Sol

Right | Sağ

0336LL

0336LR

50 pcs Adet
24x37x35 cm
~9 kg

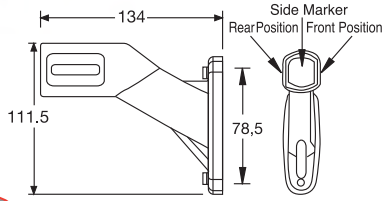

12V /24V



Side Marker with LED
Ledli Yan İşaret Lambası

Order Number | Sipariş Kodu

Left | Sol

Right | Sağ

0387LL

0387LR

50 pcs Adet
35x40x17 cm
~6,5 kg

Cable Length
Kablo Uzunluğu
25 cm

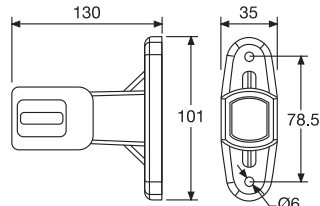

12V /24V



Side Marker with LED
Ledli Yan İşaret Lambası

Order Number
Sipariş Kodu

0338L

50 pcs Adet
34x33x19 cm
~7 kg

Cable Length
Kablo Uzunluğu
25 cm

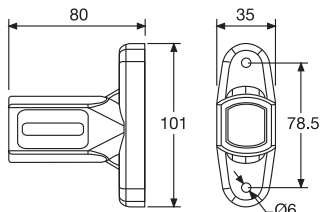

12V /24V



Side Marker with LED
Ledli Yan İşaret Lambası

Order Number
Sipariş Kodu

0339L

50 pcs Adet
26x36x20 cm
~6 kg

Cable Length
Kablo Uzunluğu
25 cm

Position Lamp

Pozisyon Lambası

Order Number | Sipariş Kodu

With Bulb Ampullü	With LED Left Ledli Sol	With LED Right Ledli Sağ
----------------------	----------------------------	-----------------------------

0084LEMKB 0084LLEDLKB 0084LLEDRKB

50 pcs Adet
38x38x23 cm
~10,5 kg

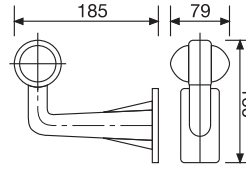

24V



Position Lamp

Pozisyon Lambası

Order Number | Sipariş Kodu

With Bulb Ampullü	With LED Left Ledli Sol	With LED Right Ledli Sağ
----------------------	----------------------------	-----------------------------

0085LEMKB 0085LLEDLKB 0085LLEDRKB

50 pcs Adet
30x46x33 cm
~8,6 kg

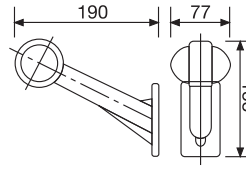

24V



Position Lamp

Pozisyon Lambası

Order Number | Sipariş Kodu

With Bulb Ampullü	With LED Left Ledli Sol	With LED Right Ledli Sağ
----------------------	----------------------------	-----------------------------

0123LEMKB 0123LLEDLKB 0123LLEDRKB

50 pcs Adet
35x40x30 cm
~9 kg

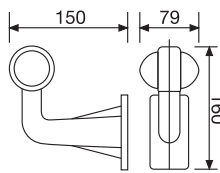

24V



Position Lamp

Pozisyon Lambası

Order Number | Sipariş Kodu

With Bulb Ampullü	With LED Left Ledli Sol	With LED Right Ledli Sağ
----------------------	----------------------------	-----------------------------

0124LEMKB 0124LLEDLKB 0124LLEDRKB

50 pcs Adet
35x40x30 cm
~9 kg

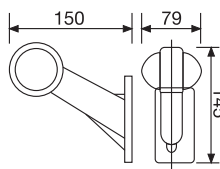

24V



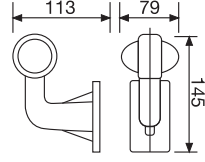

24V



Position Lamp

Pozisyon Lambası

Order Number | Sipariş Kodu

With Bulb
Ampullü

With LED Left
Ledli Sol

With LED Right
Ledli Sağ

0207LEMKB 0207LLEDLKB 0207LLEDRKB

50 pcs Adet
28x50x29 cm
~8,5 kg

Position Lamp

Pozisyon Lambası

Order Number | Sipariş Kodu

With Bulb | Ampullü

With LED | Ledli

0140LEMKB

0140LLEDKB

50 pcs Adet
30x35x23 cm
~6,5 kg

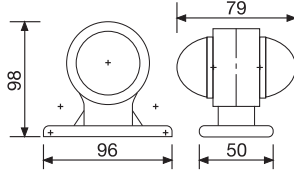

24V



Lens with LED for Side Lamps

Yan Lambalar için LED'li Lens

Order Number
Sipariş Kodu

0084CLED

100 pcs Adet
29x40x23 cm
~4,5 kg

Cable Length
Kablo Uzunluğu
50 cm

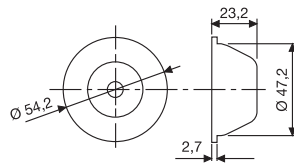
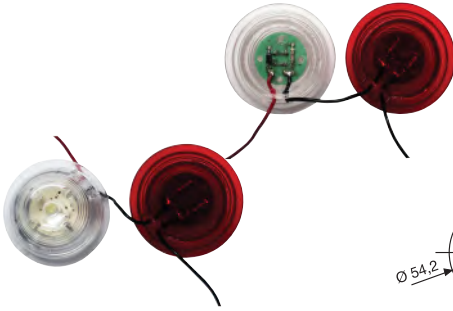

24V



Position Lamp

Pozisyon Lambası

Order Number
Sipariş Kodu

0200LEMKB

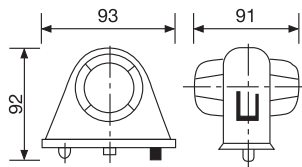

100 pcs Adet
41x48x48 cm
~16,7 kg



24V



LED Side Marker Lamps
LED'li Yan İşaret Lambaları

Function Fonksiyon	Order Number Sipariş Kodu	LED Strip Lamps LED Şerit Lamba
Side Marker Yan Marker	0365LUS	
Rear Position Arka Pozisyon	0365LUK	
Front Position Ön Pozisyon	0365LUB	

100 pcs Adet
29x40x23 cm
~8,5 kg

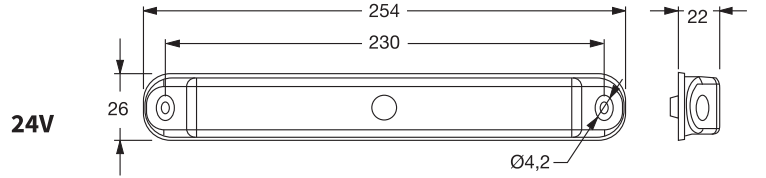

24V

Function Fonksiyon	Order Number Sipariş Kodu	Opaque LED Strip Lamps LED Opak Şerit Lamba
Side Marker Yan Marker	0410LUS12/24V	
Rear Position Arka Pozisyon	0410LUK12/24V	
Front Position Ön Pozisyon	0410LUB12/24V	



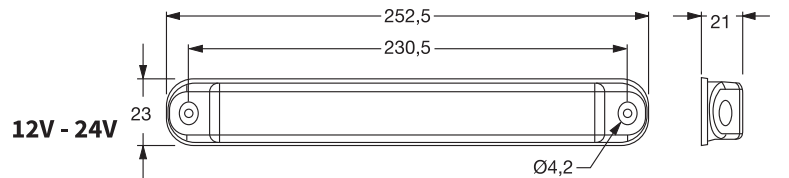

100 pcs Adet
29x40x23 cm
~11 kg



12V - 24V

LED Side Marker Lamps

LED'li Yan İşaret Lambaları

LED Strip Lamps (Includes 18 LED) with Leak Proofing Gromet 18 LED'li Lamba Sızdırmaz Grometli	Order Number Sipariş Kodu	Function Fonksiyon
	0411LUS12/24V	Side Marker Yan Marker
	0411LUK12/24V	Rear Position Arka Pozisyon
	0411LUB12/24V	Front Position Ön Pozisyon
	0412LUK12/24V	Third Stop Üçüncü Stop

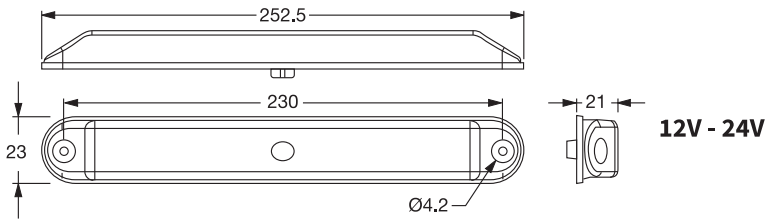

100 pcs Adet
29x40x23 cm
~10,5 kg

Cable Length | Kablo Uzunluğu : 30 cm



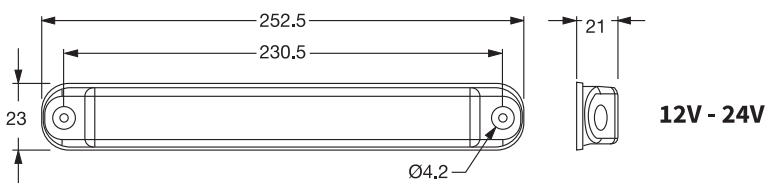









LED Lamps (Includes 18 LEDs) with Filling Material 18 LED'li Dolgu Maddeli	Order Number Sipariş Kodu	Function Fonksiyon
	0408LUS12/24V	Side Marker Yan Marker
	0408LUK12/24V	Rear Position Arka Pozisyon
	0408LUB12/24V	Front Position Ön Pozisyon
	0409LUK12/24V	Third Stop Üçüncü Stop

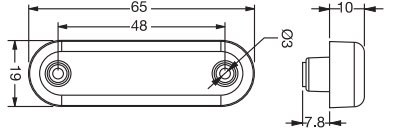

100 pcs Adet
29x40x23 cm
~10,5 kg

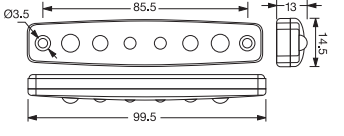
Cable Length | Kablo Uzunluğu : 30 cm

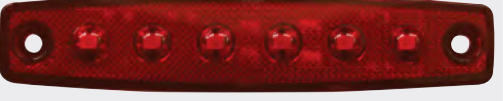
LED Side Marker Lamps
LED'li Yan İşaret Lambaları

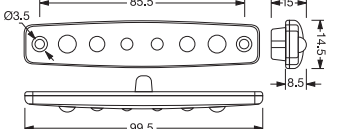
Function Fonksiyon	Order Number Sipariş Kodu	Side Marker Lamps (3 LEDs) Yan İşaret Lambası (3 LEDli)
Side Marker Yan Marker	0413LUS12/24V	
Rear Position Arka Pozisyon	0413LUK12/24V	
Front Position Ön Pozisyon	0413LUB12/24V	
150 pcs Adet 22x35x26 cm ~2,75 kg	Cable Length : 30 cm Kablo Uzunluğu 12V - 24V	 
Function Fonksiyon	Order Number Sipariş Kodu	Side Marker Lamps (Includes 6 LEDs) with Filling Material LEDli Yan İşaret Lambası (6 LEDli) Dolgu Maddeli
Side Marker Yan Marker	0308LUS12/24V	
Rear Position Arka Pozisyon	0308LUK12/24V	
Front Position Ön Pozisyon	0308LUB12/24V	
500 pcs Adet 29x40x23 cm ~9 kg	Cable Length : 30 cm Kablo Uzunluğu 12V - 24V	 
Function Fonksiyon	Order Number Sipariş Kodu	Side Marker Lamps (Includes 6 LEDs) with Leak Proofing Gromet LEDli Yan İşaret Lambası (6 LEDli) Sızdırmazlık Grometli
Side Marker Yan Marker	0307LUS12/24V	
Rear Position Arka Pozisyon	0307LUK12/24V	
Front Position Ön Pozisyon	0307LUB12/24V	
500 pcs Adet 29x40x23 cm ~7,5 kg	Cable Length : 30 cm Kablo Uzunluğu 12V - 24V	 

Truck, Trailer LED Side Marker Lamps

Çekici ve Dorse LED'li Yan Lamba

Side Marker Lamp with Single LED Tek LEDli Yan İşaret Lambası	Order Number Sipariş Kodu		Function Fonksiyon	
	Without Bracket Braketsiz	With Bracket Braketli		
		0381LUS 0381LUS12/24V	1381LUS 1381LUS12/24V	Side Marker Yan Marker
		0381LUK 0381LUK12/24V	1381LUK 1381LUK12/24V	Rear Position Arka Pozisyon
		0381LUB 0381LUB12/24V	1381LUB 1381LUB12/24V	Front Position Ön Pozisyon

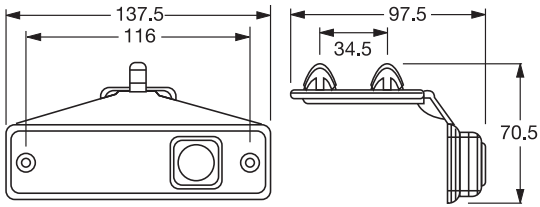

150 pcs Adet
27x50,5x27 cm
~7,5 kg

100 pcs Adet
27x50x27 cm
~8 kg



12/24V

Cable Length | Kablo Uzunluğu : 30 cm

Side Marker Lamp with LED (3 LEDs) LEDli Yan İşaret Lambası (3 LEDli)	Order Number Sipariş Kodu		Function Fonksiyon	
	Without Bracket Braketsiz	With Bracket Braketli		
		0383LUS 0383LUS12/24V	1383LUS 1383LUS12/24V	Side Marker Yan Marker
		0383LUK 0383LUK12/24V	1383LUK 1383LUK12/24V	Rear Position Arka Pozisyon
		0383LUB 0383LUB12/24V	1383LUB 1383LUB12/24V	Front Position Ön Pozisyon

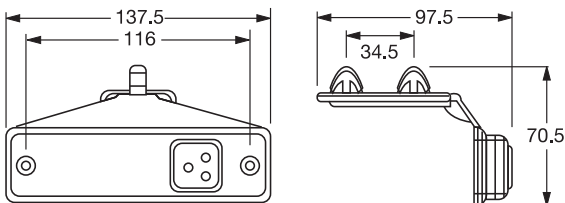

150 pcs Adet
27x50x27 cm
~7,5 kg

100 pcs Adet
27x50x27 cm
~8 kg



12/24V

Cable Length | Kablo Uzunluğu : 30 cm

Side Marker Lamp with LED (5 LEDs) with Holder
LEDli Yan İşaret Lambası (5 LEDli) - Ayarlanabilir Civatalı

Order Number Sipariş Kodu	
Without Bracket Braketsiz	With Bracket Braketli
0309LUS	1309LUS
48 pcs Adet 23x36x26 cm ~5,2 kg / 7,2 kg	Cable Length Kablo Uzunluğu 25 cm

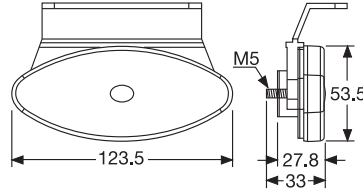

24V



Side Marker Lamp with LED (5 LEDs) with Holder
LEDli Yan İşaret Lambası (5 LEDli) - Ayarlanabilir Civatalı

Order Number Sipariş Kodu	
Without Bracket Braketsiz	With Bracket Braketli
0650LUS	1650LUS
48 pcs Adet 38x40x26 cm ~5,7 kg / 6,5 kg	Cable Length Kablo Uzunluğu 25 cm

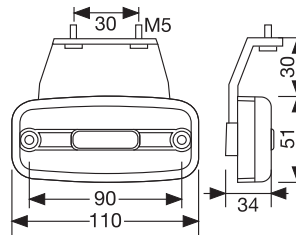

12V/24V



Side Marker Lamp with LED (3 LEDs) with Holder
LEDli Yan İşaret Lambası (3 LEDli) - Ayarlanabilir Civatalı

Order Number Sipariş Kodu	
Without Bracket Braketsiz	With Bracket Braketli
0651LUS	1651LUS
48 pcs Adet 38x40x26 cm ~5,7 kg / 6,3 kg	Cable Length Kablo Uzunluğu 25 cm

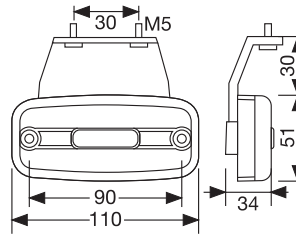

12V/24V



Side Marker Lamp with LED (1 LEDs) with Holder
LEDli Yan İşaret Lambası (1 LEDli) - Ayarlanabilir Civatalı

Order Number Sipariş Kodu	
Without Bracket Braketsiz	With Bracket Braketli
0652LUS	1652LUS
48 pcs Adet 38x40x26 cm ~5,9 kg / 6,6 kg	Cable Length Kablo Uzunluğu 25 cm

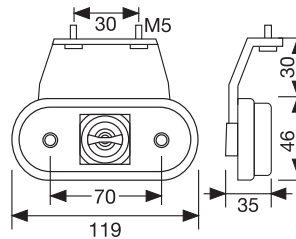

12V/24V



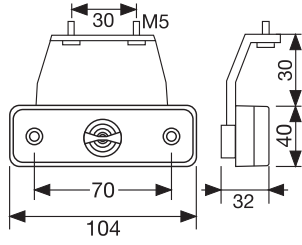

12V/24V



Side Marker Lamp with LED (1 LEDs) with Holder
LEDli Yan İşaret Lambası (1 LEDli) - Ayarlanabilir Civatalı

Order Number | Sipariş Kodu

Without Bracket
Braketsiz

With Bracket
Braketli

0654LUS

1654LUS

50 pcs Adet
38x40x26 cm
~5,5 kg / 6,3 kg

Cable Length
Kablo Uzunluğu
25 cm

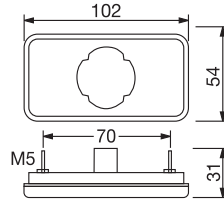

24V



Side Marker Lamp with LED (4 LEDs)
LEDli Yan İşaret Lambası (4 LEDli)

Order Number | Sipariş Kodu

Without Bracket
Braketsiz

With Bracket
Braketli

0656LUSQ25

1656LUSQ25

50 pcs Adet
38x78x18 cm
~6 kg / 7 kg

Cable Length
Kablo Uzunluğu
25 cm

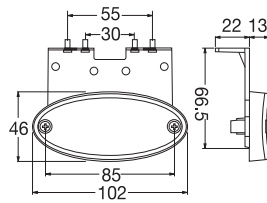

12V/24V



Side Marker Lamp with LED (1 LEDs)
LEDli Yan İşaret Lambası (1 LEDli)

Order Number | Sipariş Kodu

Without Bracket
Braketsiz

With Bracket
Braketli

0324LUS

1324LUS

Cable Length Kablo Uzunluğu 50 cm

30 pcs Adet
37x19x15 cm
~1,6 kg

30 pcs Adet
37x19x15 cm
~2,66 kg

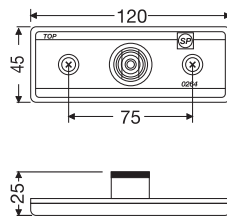

12V/24V



Side Marker Lamp with LED (4 LEDs)
LEDli Yan İşaret Lambası (4 LEDli)

Order Number | Sipariş Kodu

Without Bracket
Braketsiz

With Bracket
Braketli

0238LUS12/24V

0239LUS12/24V

100 pcs Adet
30x41x23 cm
~5 kg

Cable Length
Kablo Uzunluğu
25 cm

Side Marker Lamp with LED (5 LEDs) with Holder
LEDli Yan İşaret Lambası (5 LEDli) - Ayarlanabilir Civatalı

Order Number | Sipariş Kodu

Without Bracket
Braketsiz

With Bracket
Braketli

0223LUS

1223LUS

Cable Length Kablo Uzunluğu 125 cm

25 pcs Adet
35x13x15,5 cm
~1,7 kg

25 pcs Adet
35x13x15,5 cm
~1,9 kg



12/24V

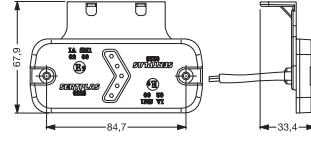

Side Marker Lamp with LED (3 LEDs) with Holder
LEDli Yan İşaret Lambası (3 LEDli) - Ayarlanabilir Civatalı

Order Number | Sipariş Kodu

Without Bracket
Braketsiz

0279LUS

50 pcs Adet
35x13x15,5 cm
~1,2 kg



12/24V

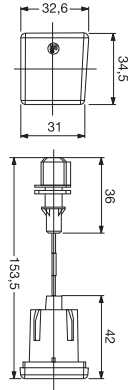

Front Position Lamp with LED (1 LED)
LEDli Ön Pozisyon Lambası (1 LEDli)

Order Number | Sipariş Kodu

Without Bracket
Braketsiz

With Bracket
Braketli

0657LUB

1657LUB

Cable Length Kablo Uzunluğu 25 cm

72 pcs Adet
38x40x26 cm
~7,5 kg

50 pcs Adet
38x40x26 cm
~6,3 kg



12/24V

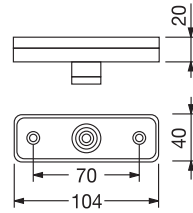

Front Position Lamp with LED (1 LED)
LEDli Ön Pozisyon Lambası (1 LEDli)

Order Number | Sipariş Kodu

Without Bracket
Braketsiz

With Bracket
Braketli

0657LE

1657LE

72 pcs Adet
38x40x26 cm
~7,2 kg / 8,5 kg

Cable Length
Kablo Uzunluğu
25 cm



12/24V

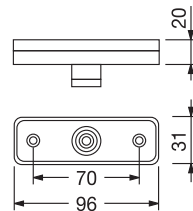

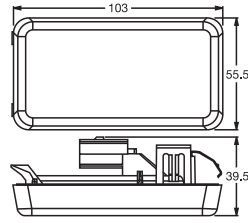
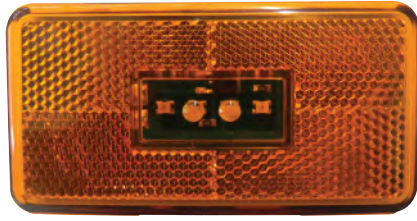

12/24V



Side Marker Lamp with LED (4 LEDs) (SCN PGRI Series)
LEDli Yan İşaret Lambası (4 LEDli) -(SCN PGRI Serisi)

Order Number
Sipariş Kodu

0247LUS

35 pcs Adet
37x19x15 cm
~2,4 kg

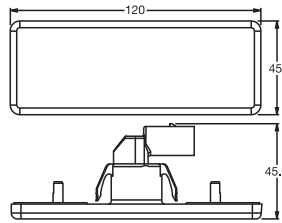

12/24V



Side Marker Lamp with LED (6 LEDs) (MRC ACTRS Series)
LEDli Yan İşaret Lambası (6 LEDli) (MRC ACTRS Serisi)

Order Number
Sipariş Kodu

0240LUS

36 pcs Adet
37x19x15 cm
~2 kg

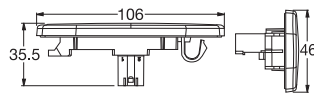

12/24V



Side Marker Lamp with LED (1 LEDs)
LEDli Yan İşaret Lambası (1 LEDli)

Order Number
Sipariş Kodu

0241LUS

32 pcs Adet
35x13x15,5 cm
~1,5 kg



Socket Type | Soket Tipi

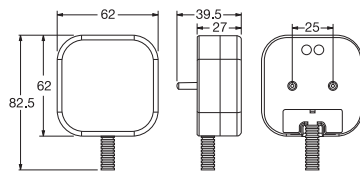

12/24V



Side Marker Lamp with LED (4 LEDs) (TGA Series)
LEDli Yan İşaret Lambası (4 LEDli) (TGA Serisi)

Order Number
Sipariş Kodu

0273LUS

Order Number
Sipariş Kodu

0268LUS

36 pcs Adet
22x35,5x26 cm
~3,4 kg

Cable Length
Kablo Uzunluğu
140 cm

Side Marker Lamp (for Sprinter) Yan İşaret Lambası (Sprinter için)

Order Number Sipariş Kodu	
Without Socket Soketsiz	With Socket Soketli

0242LUSQ

0242LUS

30 pcs Adet
35x13x15,5 cm
~1,5 kg



BULB : W5W

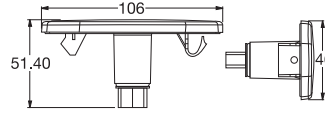

Socket Set : QSK25-STŞ



Side Marker Lamp Yan İşaret Lambası

Order Number Sipariş Kodu	
With Bracket Braketli	

0259LUS
0260LUS

100 pcs Adet
30x41x23 cm
~7 kg



BULB : W5W

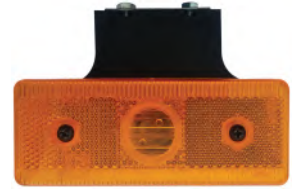
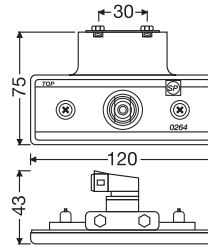

Socket Type | Soket Tipi

0259LUS 0260LUS



Side Marker Lamp Yan İşaret Lambası

Order Number Sipariş Kodu	
Without Bracket Braketsiz	

0264LUS
0265LUS

50 pcs Adet
22x36x26 cm
~6,5 kg



BULB : W5W

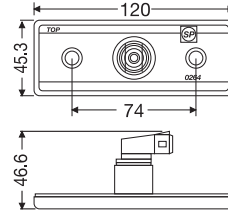

Socket Type | Soket Tipi

0264LUS 0265LUS



Side Marker Lamp Yan İşaret Lambası

Order Number Sipariş Kodu	
Without Socket Soketsiz	With Socket Soketli

0249LUSQ

0249LUS

18 pcs Adet
29x11x19 cm
~1,4 kg



BULB : W5W

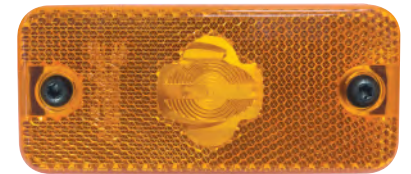
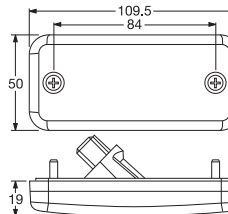

Socket Set : QSK25-STŞ



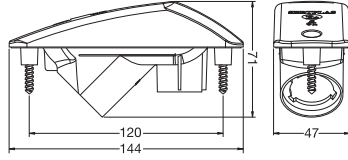

24V/21W

Side Indicator Lamp (DF Truck)
 Yan Sinyal Lambası

 Order Number
 Sipariş Kodu

0275LUS

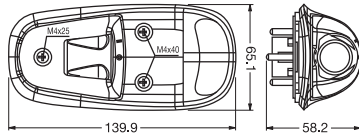
 32 pcs Adet
 29x36x32 cm
 ~5,2 kg

24V/5W



Front Position Lamp (DF, RNL, VW Trucks)
 Ön Pozisyon Lambası

 Order Number
 Sipariş Kodu

0276LUB

 72 pcs Adet
 36x39x31 cm
 ~5,2 kg

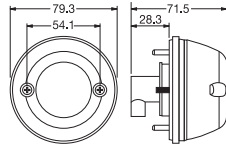
Product Includes Bulb



24V/21W

Side Indicator Lamp
 Yan Sinyal Lambası

Order Number | Sipariş Kodu

 With Socket
 Soketli

0272LUS

 35 pcs Adet
 29x40x23 cm
 ~3,5 kg

Socket Type | Soket Tipi

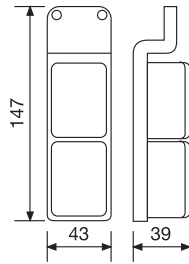
Side Marker Lamp, Double Red/Clear, Red/Amber, Amber, Clear, Red/Blue and Different Colours are available
 Yan İşaretleme Lambası Kırmızı/Şeffaf, Kırmızı/Sarı, Sarı, Şeffaf, Mavi ve Farklı Renkler Üretilir.

 Order Number
 Sipariş Kodu

 Only Lens Code
 Tek Cam Kodu

0304L
0305C

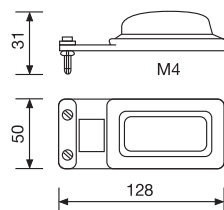
 100 pcs Adet
 29x40x23 cm
 ~9,5 kg

Side Marker Lamp, Double Red/Clear, Red/Amber, Amber, Clear, Red/Blue and Different Colours are available
 Yan İşaretleme Lambası Kırmızı/Şeffaf, Kırmızı/Sarı, Sarı, Şeffaf, Mavi ve Farklı Renkler Üretilir.

 Order Number
 Sipariş Kodu

 Only Lens Code
 Tek Cam Kodu

0201L
0201C

 100 pcs Adet
 29x40x23 cm
 ~6,4 kg

 100 pcs Adet
 29x40x23 cm
 ~6,4 kg

Saturn Lamp Ex-Proof Lamp for Marine&Vehicles
Satürn Lamba - Kara ve Deniz Araçları için
Patlamaya Dayanıklı Lamba

Order Number
Sipariş Kodu

0011L

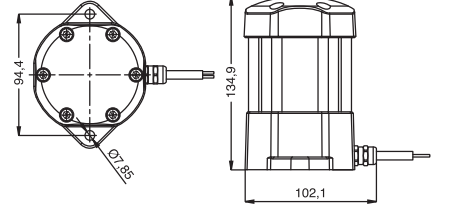

Indoor - Ceiling Lamp
İç Aydınlatma Lambası

Order Number
Sipariş Kodu

0356LUB

36 pcs Adet
29x40x23 cm
~4,3 kg

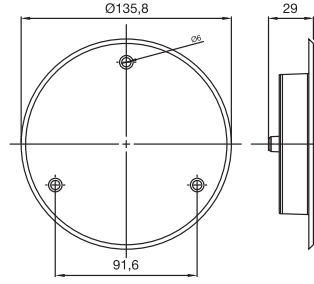

12V/24V

LED

Indoor - Ceiling Lamp
İç Aydınlatma Lambası

Order Number | Sipariş Kodu

With Bulb With LED 24V With LED 12V Only Lens
Ampullü LEDli 24V LEDli 12V Sadece Cam

0341L 0341LLED24V 0341LLED12V 0341CU

40 pcs Adet
41x48x48 cm
~5 kg

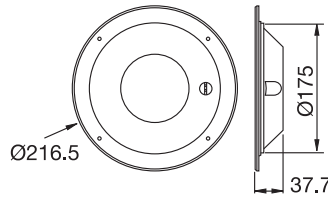

12V/24V



Indoor - Ceiling Lamp
İç Aydınlatma Lambası

Order Number
Sipariş Kodu

0355LUB

24 pcs Adet
27x50,5x27 cm
~7,46 kg

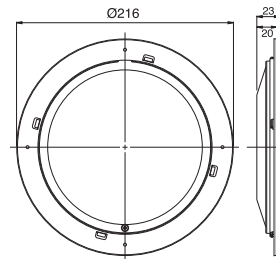

12V/24V

LED

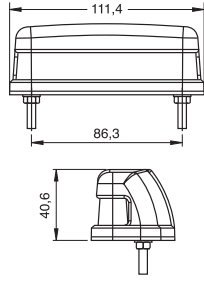

12V/24V

Number Plate Lamp with LED (5 LEDs)
 LEDli Plaka Lambası (5 LEDli)

 Order Number
 Sipariş Kodu

0092LUB

 27 pcs Adet
 37x19x15 cm
 ~3 kg

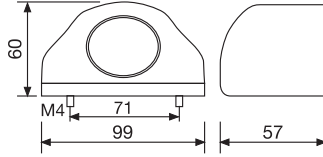
 Cable Length
 Kablo Uzunluğu
 50 cm

12V/24V

Number Plate Lamp with Bulb (5 Watt) with LED
 Plaka Lambası Ampullü (5 Watt) LEDli

Order Number | Sipariş Kodu

 With Bulb
 Ampullü

 With LED
 LEDli

0250LUZ
0250LEDZ

 100 pcs Adet
 41x48x49 cm
 ~13,8 kg

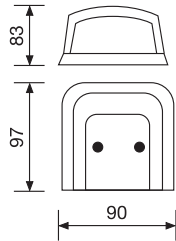
 Cable Length
 Kablo Uzunluğu
 50 cm

Number Plate Lamp, R12
 R12 Plaka Lambası

 Order Number
 Sipariş Kodu

 Only Lens Code
 Sadece Cam Kodu

0133L
0133C

 48 pcs Adet
 29x40x23 cm
 ~17,5 kg

Number Plate & Reverse Lamp, R12
 R12 Plaka & Geri Vites Lambası

 Order Number
 Sipariş Kodu

 Only Lens Code
 Sadece Cam Kodu

0134L
0134C

 63 pcs Adet
 29x40x23 cm
 ~25,5 kg

Triangular Reflector | Üçgen Reflektör

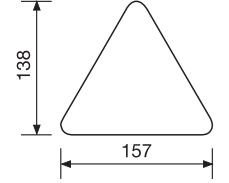
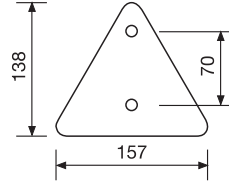
(Red, White, Yellow Colours available)
Kırmızı, Beyaz, Sarı renklerde üretilebilir)Order Number
Sipariş KoduImperforate
Deliksiz**9313A****9313B**500 pcs Adet
27x50,5x27 cm
~12,8 kg500 pcs Adet
27x50,5x27 cm
~12,8 kg

Marker Reflector Triangular | Üçgen Reflektör

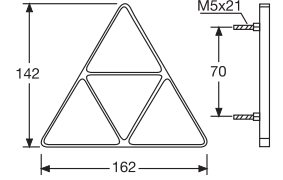
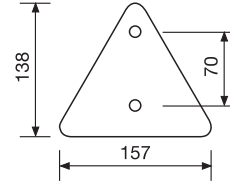
(Uniform Different Colours available)
Farklı renklerde üretilebilir)Order Number
Sipariş KoduImperforate
Deliksiz**9315****9312**500 pcs Adet
27x50,5x27 cm
~12,8 kg500 pcs Adet
27x50,5x27 cm
~12,8 kg

Rectangular Reflector Black Base

Dikdörtgen Siyah Tabanlı Reflektör

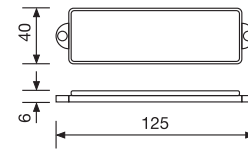
Order Number
Sipariş Kodu**9411UAK**500 pcs Adet
27x50,5x27 cm
~12,7 kg

Warning Triangular Reflector

Üçgen Uyarı Reflektör

Order Number
Sipariş Kodu**9046Q1**

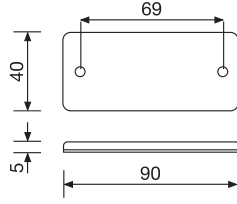
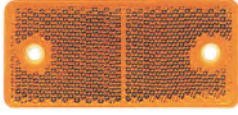

E9



Marker Reflector Rectangular | Dörtgen Reflektör
(Uniform Different Colours available / Farklı renklerde üretilebilir)

Order Number | Sipariş Kodu

White | Beyaz Amber | Amber

9419UAB/B

9419UAS/B

500 pcs Adet
27x50,5x27 cm
~11,3 kg

Marker Reflector Rectangular Sticker Type
Dörtgen Reflektör Etiket Tip
(Uniform Different Colours available / Farklı renklerde üretilebilir)

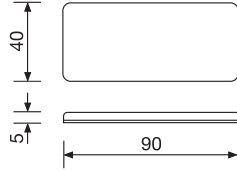
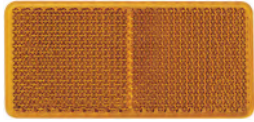

E9



Order Number | Sipariş Kodu

White | Beyaz Amber | Amber

9429UAB/B

9429UAS/B

500 pcs Adet
27x50,5x27 cm
~11,3 kg

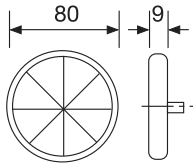

Annular Reflector | Dairesel Reflektör
(Uniform Different Colours available / Farklı renklerde üretilebilir)

Order Number | Sipariş Kodu

Red | Kırmızı White | Beyaz Amber | Amber

9118UAK/B

9118UAB/B

9118UAS/B

500 pcs Adet
27x50,5x27 cm
~12 kg



Annular Reflector
Dairesel Reflektör

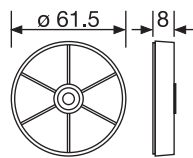

Order Number | Sipariş Kodu

Red | Kırmızı White | Beyaz Amber | Amber

9126UAK/B

9126UAB/B

9126UAS/B

500 pcs Adet
27x50,5x27 cm
~11,8 kg



Marker Reflector Rectangular

Dörtgen Reflektör Petek Desen

(Uniform Different Colours available / Farklı renklerde üretilebilir)

Order Number | Sipariş Kodu

Amber | Amber White | Beyaz Red | Kırmızı

9410UAS/B 9410UAB/B 9410UAK/B

600 pcs Adet
27x50,5x27 cm
~15,8 kg

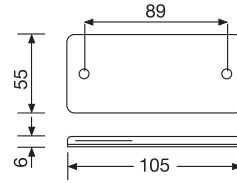
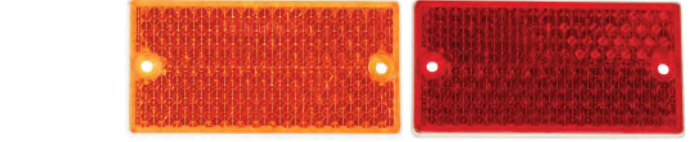

Marker Reflector Triangular | Üçgen Reflektör

(Uniform Different Colours available)

Farklı renklerde üretilebilir)

Order Number | Sipariş Kodu

Amber | Amber White | Beyaz Red | Kırmızı

9327UAS 9327UAB 9327UAK

500 pcs Adet
27x50,5x27 cm
~11,8 kg

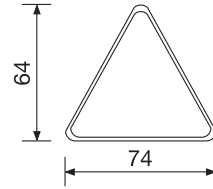
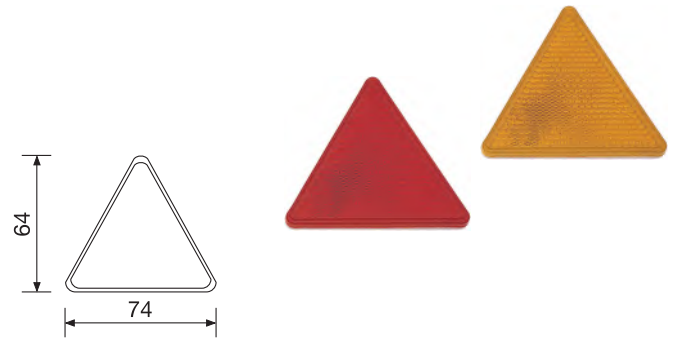

Triangular Reflector, Small | Üçgen Reflektör, Küçük

(Uniform Different Colours available)

Farklı renklerde üretilebilir)

Order Number | Sipariş Kodu

Red | Kırmızı White | Beyaz Amber | Amber

9328UAK/B 9328UAB/B 9328UAS/B

500 pcs Adet
27x50,5x27 cm
~11,8 kg

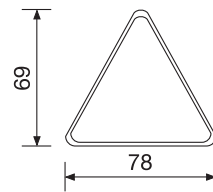
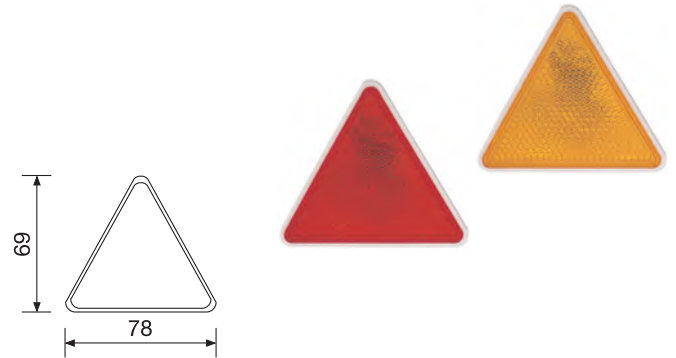

Annular Reflector

Dairesel Reflektör

Order Number | Sipariş Kodu

Red | Kırmızı White | Beyaz Amber | Amber

9125UAK 9125UAB 9125UAS

500 pcs Adet
29x40x23 cm
~11,8 kg

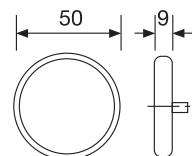
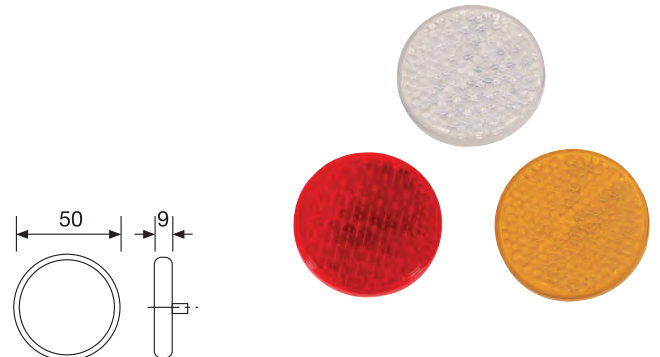

Triangular Reflector (with Adhesive)
Üçgen Reflektör (Yapıştırıcılı)

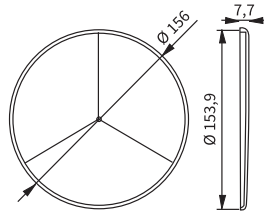

Order Number
Sipariş Kodu

9316

E9



100 pcs Adet
29x40x23 cm
~11 kg

Triangular Reflector (with Screw Holes)
Üçgen Reflektör (Vidalı Montaj)

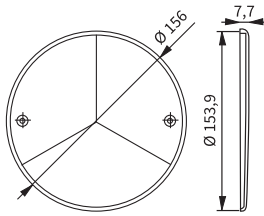

Order Number
Sipariş Kodu

9317

E9



100 pcs Adet
29x40x23 cm
~11 kg

Rectangular Yellow Reflector with White Base
Beyaz Tabanlı Sarı Dikdörtgen Reflektör

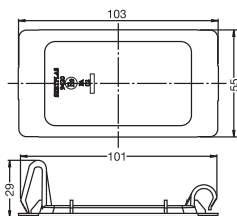

Order Number
Sipariş Kodu

9420



30 pcs Adet
13x35x15,5 cm
~12,7 kg

Pneumatic P.A. 12 Polyamide Tubes for Air Brake Systems

Pnömatik P.A. 12 Poliamid Tır Dorse Havalı Fren Hortumları



Material PA 12
Materyal

Color Black
Renk

Coil Size 25m, 50m, 100m, 500m available
Sarmın Uzunluğu

Branding Tube I.D., O.D. / Material / Spec.
Markalama I.D., O.D. / Materyal / Spek

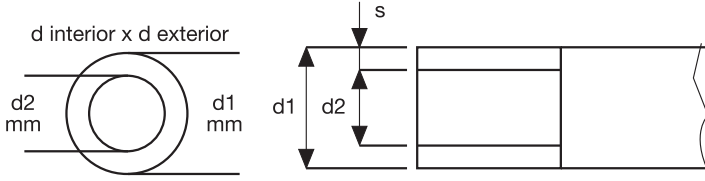

Min. Bend
Radius at 23° C
Min. Bükülme
Çapı 23° C' de

Working
Pressure at 23° C
Çalışma Basıncı
23° C' de

Inner Diameter İç Çap	Outer Diameter Dış Çap	Wall Thickness Duvar Kalınlığı	r (mm)	Po (bar)	Order Number Sipariş Kodu
2	4	1	20	45	QHTPA0204Z
3	4	0.5			QHTPA0304Z
4	6	1	35	27	QHTPA0406Z
6	8	1	40	19	QHTPA0608Z
6	9	1.5	45	27	QHTPA0609Z
6	10	2			QHTPA0610Z
7	10	1.5	70	23	QHTPA0710Z
7.5	10	1.25	75	19	QHTPA07510Z
8	10	1	50	15	QHTPA0810Z
8	11	1.5	65	21	QHTPA0811Z
9	11	1			QHTPA0911Z
8	12	2	60		QHTPA0812Z
9	12	1.5		19	QHTPA0912Z
10	12.5	1.25	80		QHTPA1012/5Z
10	14	2		21	QHTPA1014Z
11	15	2	95		QHTPA1115Z
12	15	1.5	100	15	QHTPA1215Z
12	16	2	115	19	QHTPA1216Z
14	18	2	115	17	QHTPA1418Z
16	20	2	100	16	QHTPA1620Z

Pneumatic Polyurethane, Polyethylene Tubes

Pnömatik Poliüretan, Polietilen Hava Hortumları

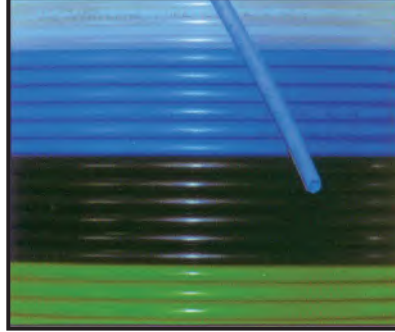
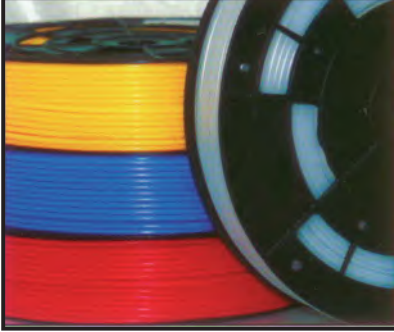

Polyurethane Tubes Poliüretan Hortumlar	Polyethylene Tubes Polietilen Hortumlar	Inner d.xOuter d. İç Çap x Dış Çap (mm)	Length per Coil Bobin Uzunluğu (meters)	Yellow	Red	Blue	Black	White	Green
QHTPU0204	QHTPE0204	2 x 4	200			●	●	●	
QHTPU0304	QHTPE0304	3 x 4	200			●	●	●	
QHTPU0305	QHTPE0305	3x5	200			●	●	●	
QHTPU0406	QHTPE0406	4 x 6	200	●	●	●	●	●	●
QHTPU0407	QHTPE0407	4 x 7	100				●		
QHTPU0408	QHTPE0408	4 x 8	100		●		●		
QHTPU0508	QHTPE0508	5 x 8	100		●		●		
QHTPU05.508	QHTPE05.508	5.5 x 8	100				●		
QHTPU0608	QHTPE0608	6 x 8	100	●	●	●	●	●	●
QHTPU0610	QHTPE0610	6 x 10	100		●		●		
QHTPU06.510	QHTPE06.510	6.5 x 10	100		●		●		
QHTPU07.510	QHTPE07.510	7.5 x 10	100				●		
QHTPU0810	QHTPE0810	8 x 10	100			●	●	●	
QHTPU0812	QHTPE0812	8 x 12	100		●		●		
QHTPU0911	QHTPE0911	9 x 11	100	●		●	●	●	
QHTPU0912	QHTPE0912	9 x 12	100				●		
QHTPU0913	QHTPE0913	9 x 13	50				●		
QHTPU1012	QHTPE1012	10 x 12	100				●	●	
QHTPU1014	QHTPE1014	10 x 14	50				●		
QHTPU1016	QHTPE1016	10 x 16	50		●		●		
QHTPU1216	QHTPE1216	12 x 16	50		●		●		●

Air Brake Connection Fittings for Trailer
Treyler Havalı Fren Bağlantı Sekmanları

Order Number | Sipariş Kodu Size Boyut

Nipel Nipel



SP020404	4
SP020606	6
SP020707	7
SP020808	8
SP020909	9
SP021010	10
SP021111	11
SP021212	12
SP021414	14
SP021616	16

Order Number | Sipariş Kodu Size Boyut

Male Stud Run Elbow 90° Cıvatalı Erkek 90°



SP041804	1/8-4
SP041806	1/8-6
SP041406	1/4-6
SP043806	3/8-6
SP041808	1/8-8
SP041408	1/4-8
SP043808	3/8-8
SP041410	1/4-10
SP043810	3/8-10
SP041412	1/4-12
SP043812	3/8-12

Elbow 90° 90° Dirsek



SP050404	4 - 4
SP050606	6 - 6
SP050808	8 - 8
SP051010	10 - 10
SP051212	12 - 12

Reducer T Redüktör T



SP104406	4 - 4 - 6
SP106604	6 - 6 - 4
SP108806	8 - 8 - 6
SP106608	6 - 6 - 8
SP108810	8 - 8 - 10
SP10101008	10 - 10 - 8
SP10101012	10 - 10 - 12
SP10121210	12 - 12 - 10

Male Stud BSP P&M Branch T Erkek BSP P&M Dağıtım T



SP061804	1/8-4
SP061806	1/8-6
SP061406	1/4-6
SP063806	3/8-6
SP061808	1/8-8
SP061408	1/4-8
SP063808	3/8-8
SP061410	1/4-10
SP063810	3/8-10
SP061412	1/4-12
SP063812	3/8-12

Male Stud Run Tee BSP P&M Erkek BSP P&M Dağıtım T



SP071804	1/8-4
SP071806	1/8-6
SP071406	1/4-6
SP073806	3/8-6
SP071808	1/8-8
SP071408	1/4-8
SP073808	3/8-8
SP071410	1/4-10
SP073810	3/8-10
SP071412	1/4-12
SP073812	3/8-12

Tee T Şeklinde



SP030404	4
SP030606	6
SP030808	8
SP031010	10
SP031212	12

Reducer Redüktör



SP090604	6 - 4
SP090806	8 - 6
SP091008	10 - 8
SP091210	12 - 10

Air Brake Connection Fittings for Trailer Treyler Havalı Fren Bağlantı Sekmanları

Order Number Sipariş Kodu	Size	Boyut
-----------------------------	------	-------

Nipel	Nipel	
	SM020404	4
	SM020606	6
	SM020707	7
	SM020808	8
	SM020909	9
	SM021010	10
	SM021111	11
	SM021212	12
	SM021313	13
	SM021414	14
	SM021515	15
	SM021616	16

Tee T Şeklinde	
----------------	--

	SM030404	4
	SM030606	6
	SM030808	8
	SM031010	10
	SM031212	12

Male Stud BSP P&M Branch T	Erkek BSP P&M Dağıtım T
----------------------------	-------------------------

	SM061804	1/8-4
	SM061806	1/8-6
	SM061406	1/4-6
	SM063806	3/8-6
	SM061808	1/8-8
	SM061408	1/4-8
	SM063808	3/8-8
	SM061410	1/4-10
	SM063810	3/8-10
	SM061412	1/4-12
	SM063812	3/8-12

Female Stud BSP P&M	Dişi Cıvatalı BSP P&M
---------------------	-----------------------

	SM081804	1/8-4
	SM081806	1/8-6
	SM081406	1/4-6
	SM083806	3/8-6
	SM081808	1/8-8
	SM081408	1/4-8
	SM083808	3/8-8
	SM081410	1/4-10
	SM083810	3/8-10
	SM081412	1/4-12
	SM083812	3/8-12

Order Number Sipariş Kodu	Size	Boyut
-----------------------------	------	-------

Male Stud BSP P&M	Erkek Cıvatalı BSP P&M	
	SM01M404	M 4-4
	SM01M504	M 5-4
	SM01M604	M 6-4
	SM011804	1/8-4
	SM011806	1/8-6
	SM011406	1/4-6
	SM013806	3/8-6
	SM011808	1/8-8
	SM011408	1/4-8
	SM013808	3/8-8
	SM011410	1/4-10
	SM013810	3/8-10
	SM011412	1/4-12
	SM013812	3/8-12

Male Stud Run Elbow 90°	Cıvatalı Erkek 90° Dirsek
-------------------------	---------------------------

	SM041804	1/8-4
	SM041806	1/8-6
	SM041406	1/4-6
	SM043806	3/8-6
	SM041808	1/8-8
	SM041408	1/4-8
	SM043808	3/8-8
	SM041410	1/4-10
	SM043810	3/8-10
	SM041412	1/4-12
	SM043812	3/8-12

Male Stud Run BSP P&M	Erkek Cıvatalı Akış BSP P&M
-----------------------	-----------------------------

	SM071804	1/8-4
	SM071806	1/8-6
	SM071406	1/4-6
	SM073806	3/8-6
	SM071808	1/8-8
	SM071408	1/4-8
	SM073808	3/8-8
	SM071410	1/4-10
	SM073810	3/8-10
	SM071412	1/4-12
	SM073812	3/8-12

Reducer	Redüktör
---------	----------

	SM090604	06-04
	SM090806	08-06
	SM091008	10-08
	SM091210	12-10

Male Reducer	Erkek Redüktör
--------------	----------------

	SM100604	06-04
	SM100806	08-06
	SM101008	10-08
	SM101210	12-10

Trailer Tool Box 80 Liters
Dorse Alet Çantası 80 Litre

Order Number
Sipariş Kodu

5507A

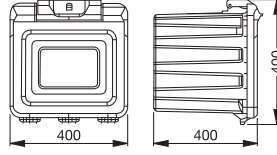

1 pc Adet
40x43x45 cm
~3,65 kg



Trailer Tool Box 80 Liters
Dorse Alet Çantası 80 Litre

Order Number
Sipariş Kodu

5504A

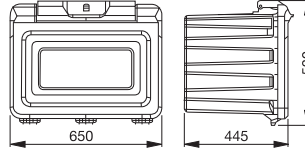

1 pc Adet
65x52,5x47 cm
~6,9 kg



Trailer Tool Box 110 Liters
Dorse Alet Çantası 110 Litre

Order Number
Sipariş Kodu

5503A

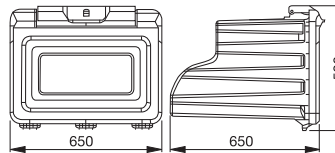

1 pc Adet
52,5x64,5x66 cm
~7,35 kg



Trailer Tool Box 100 Liters
Dorse Alet Çantası 100 Litre

Order Number
Sipariş Kodu

5500

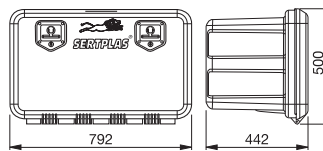

1 pc Adet
50x79,5x43,6 cm
~10,9 kg



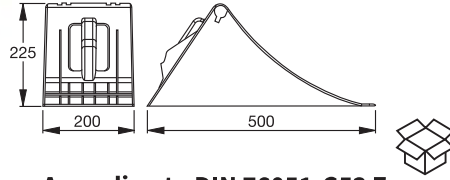

*Wheel Radius (in mm): 530

According to DIN 76051-G53 Z

Trailer Wheel Chock

Tır Takozu

Order Number | Sipariş Kodu

Complete with Holder
Tutucu ile birlikte

Without Holder
Tutucu olmadan

5502AB

5502A

6 pcs Adet
37x80x51 cm
~16 kg

6 pcs Adet
32x61x51 cm
~12,1 kg

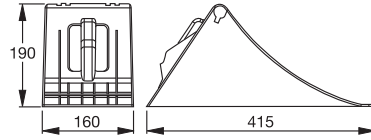

*Wheel Radius (in mm): 460

According to DIN 76051-G46 Z

Trailer Wheel Chock

Tır Takozu

Order Number
Sipariş Kodu

5506A

6 pcs Adet
26x60x41 cm
~7,6 kg



according to
ISO4892-3 ISO3795



Trailer Fire Extinguisher Box (6 to 9 Kilos)

Yangın Söndürme Kutusu (6 ila 9 Kilo)

Order Number | Sipariş Kodu

With 1 inner Clamp
1 Kıskaçlı

With 2 inner Clamp
2 Kıskaçlı

5501A

5501B

6 pcs Adet
59x70x78 cm
~25,10 kg

6 pcs Adet
59x70x78 cm
~26,35 kg



according to
UL94 ISO3795



Trailer Fire Extinguisher Box (6 Kilos)

Yangın Söndürme Kutusu (6 Kilo)

Order Number
Sipariş Kodu

5510

6 pcs Adet
55,5x55,5x59 cm
~12,66 kg

Water Jug 30 Liters

Su Deposu 30 Litre

Order Number
Sipariş Kodu**5505A**6 pcs Adet
69x37x125 cm
~16,35 kg

Water Jug 30 Liters

Su Deposu 30 Litre

Order Number
Sipariş Kodu**5511**6 pcs Adet
39,5x65,5x137 cm
~17,5 kg

Water Jug 40 Liters

Su Deposu 40 Litre

Order Number
Sipariş Kodu**5514**4 pcs Adet
50x93x49 cm
~12,70 kg

Fuel Tank

Yakıt Deposu

Order Number | Sipariş Kodu

20 Liters | 20 Litre

10 Liters | 10 Litre

5508**5509**

20 Lt

10 Lt

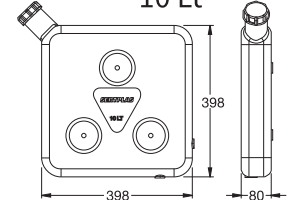
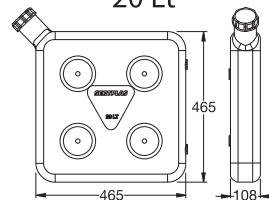

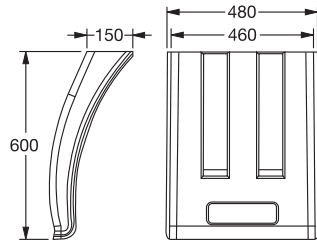

Plastic Half-Wing
Plastik Çamurluk

Order Number
Sipariş Kodu

1307

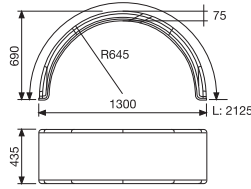

Mudguard (White Strip)
Çamurluk (Beyaz Çizgili)

Order Number | Sipariş Kodu

Mudguard with White Strip
Beyaz Çizgili

Mudguard without White Strip
Beyaz Çizgisiz

1301P

1302P

**Different Strip Colours are Available
Reflector Strips are Also Available**

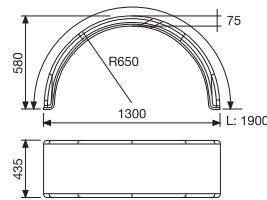

Mudguard (White Strip)
Çamurluk (Beyaz Çizgili)

Order Number | Sipariş Kodu

Mudguard with White Strip
Beyaz Çizgili

Mudguard without White Strip
Beyaz Çizgisiz

1303P

1304P

**Different Strip Colours are Available
Reflector Strips are Also Available**



Adjustable Support for Mudguard
Çamurluk için Tutucu Destek

Order Number
Sipariş Kodu

2478



50 pcs Adet
41x41x41 cm
~15,3 kg

Truck / Lorry Warning Board

Tır / Kamyon Uyarı Panosu

Order Number Sipariş Kodu

9020

Aluminium Base / Alüminyum Taban

Board Size : 560x135 mm 2 Piece



Truck / Trailer Warning Board

Tır / Römork Uyarı Panosu

Order Number Sipariş Kodu

9019

Aluminium Base / Alüminyum Taban

Board Size : 565x200 mm 2 Piece



Custom Area Warning Board

Gümrük Levhası

Order Number Sipariş Kodu

With Pocket | Cepli

Without Pocket | Cepsiz

9003.A1**9003.A2**

Board Size : 300x200 mm

Heavy Vehicle Load Carrying Warning Board

Ağır Araç Taşıyıcı İkaz Plaketi

Order Number Sipariş Kodu

Aluminium Base
Alüminyum TabanGalvanise Base
Galvaniz Taban

9011Q2 350x350 mm	9011 350x350 mm
DM9011Q1 423x423 mm	

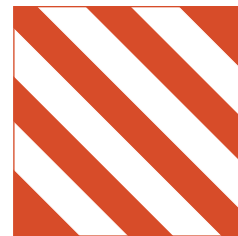

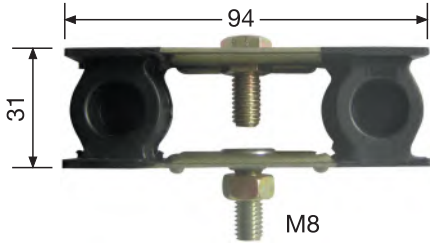

Suitable for all Types of Truck

Shock Absorber for Tail Lamps
Tır Stop Lamba Titreşim Emici Ayağı

Order Number
Sipariş Kodu

0344A

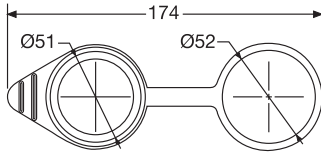

Washer Fluid Reservoir Cap
Silecek Deposu Kapağı

Order Number
Sipariş Kodu

2284

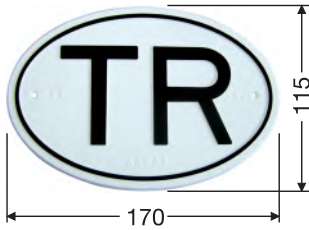

Euro - Countries Sign Plates
Elips TR Plakası

Order Number
Sipariş Kodu

9016

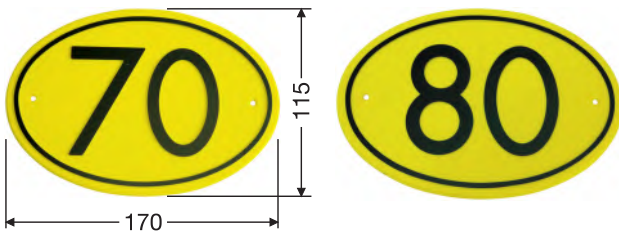

Speed Limit Sign Plates
Hız Sınırı İşaret Plakaları

Order Number | Sipariş Kodu

70 Km

80 Km

9017

9018

Flat Printed Mudflaps

Düz Yazılı Paçalık

Order Number Sipariş Kodu	
35x50 mm	40x60 mm

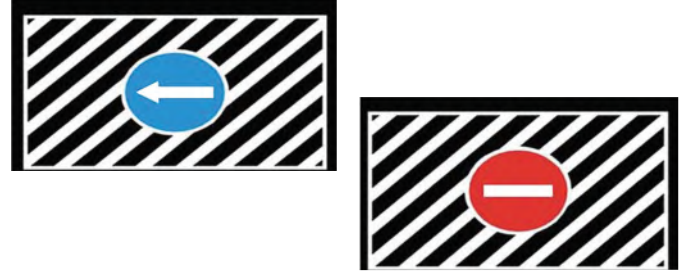
DM990134**DM990135**

* Includes two pieces

Embossed Printed Mudflaps

Kabartma Yazılı Paçalık

Order Number Sipariş Kodu	
30x64 mm	36x64 mm

DM990139**DM990140**

* Includes two pieces

Order Number Sipariş Kodu	
40x45 mm	40x60 mm

DM990138**DM990141**

Flat Printed Mudflaps

Düz Yazılı Paçalık

Order Number Sipariş Kodu	
35x240 mm	

DM990136

Embossed Printed Mudflaps

Kabartma Yazılı Paçalık

Order Number Sipariş Kodu	
35x240 mm	

990137

TIE-DOWNS, RATCHET STRAPS, RATCHET BUCKLES, HOOKS

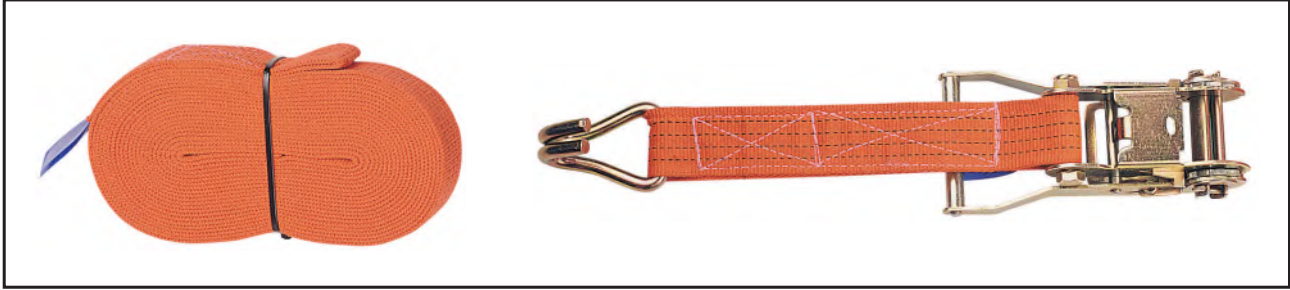

5475	5460	5445
CNR Poliester Strap 5 ton / 10 ton MBS 7,5 ton 8 Metres CNR Polyester Spanset 5 ton / 10 ton MBS 7,5 ton 8 Metre	CNR Poliester Strap 4 ton / 8 ton MBS 6 ton 8 Metres CNR Polyester Spanset 4 ton / 8 ton MBS 6 ton 8 Metre	CNR Poliester Strap 4 ton / 8 ton MBS 4,5 ton 8 Metres CNR Polyester Spanset 4 ton / 8 ton MBS 4,5 ton 8 Metre
Order Number Sipariş Kodu	Order Number Sipariş Kodu	Order Number Sipariş Kodu
5475/8	5460/8	5445/8
CNR Poliester Strap 5 ton / 10 ton MBS 7,5 ton 10 Metres CNR Polyester Spanset 5 ton / 10 ton MBS 7,5 ton 10 Metre	CNR Poliester Strap 4 ton / 8 ton MBS 6 ton 10 Metres CNR Polyester Spanset 4 ton / 8 ton MBS 6 ton 10 Metre	CNR Poliester Strap 4 ton / 8 ton MBS 4,5 ton 10 Metres CNR Polyester Spanset 4 ton / 8 ton MBS 4,5 ton 10 Metre
Order Number Sipariş Kodu	Order Number Sipariş Kodu	Order Number Sipariş Kodu
5475/10	5460/10	5445/10
CNR Poliester Strap 5 ton / 10 ton MBS 7,5 ton 12 Metres CNR Polyester Spanset 5 ton / 10 ton MBS 7,5 ton 12 Metre	CNR Poliester Strap 4 ton / 8 ton MBS 6 ton 10 Metres CNR Polyester Spanset 4 ton / 8 ton MBS 6 ton 12 Metre	CNR Poliester Strap 4 ton / 8 ton MBS 4,5 ton 10 Metres CNR Polyester Spanset 4 ton / 8 ton MBS 4,5 ton 12 Metre
Order Number Sipariş Kodu	Order Number Sipariş Kodu	Order Number Sipariş Kodu
5475/12	5460/12	5445/12

WIRING OF SOCKET & PLUGS ACCORDING TO INTERNATIONAL STANDARDS

ISO 1724 12V / 7 pins

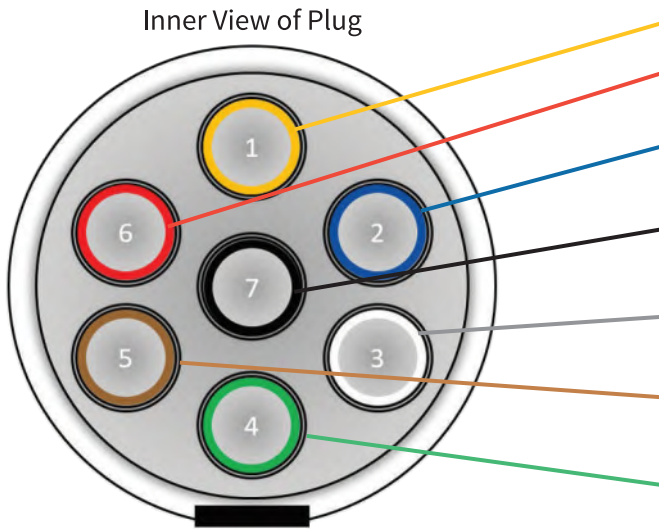

Left-hand direction light | SOL sinyal

Stop lamp | Stop lambası

+12V from battery Rear fog lamps
Aküden +12V veya Arka sis lambası

Left-hand rear position and marker lights and rear-
registration-plate illumination device | SOL arka lamba,
pozisyon, işaret lambaları ve plaka aydınlatma

Ground connected to chassis | Toprak şasi bağlantısı

Right-hand rear position and marker lights and rear-
registration-plate illumination device | SAĞ arka pozisyon,
işaret lambaları ve plaka aydınlatma

Right-hand direction indicator light | SAĞ sinyal

ISO 1185 N type 24V / 7 pins

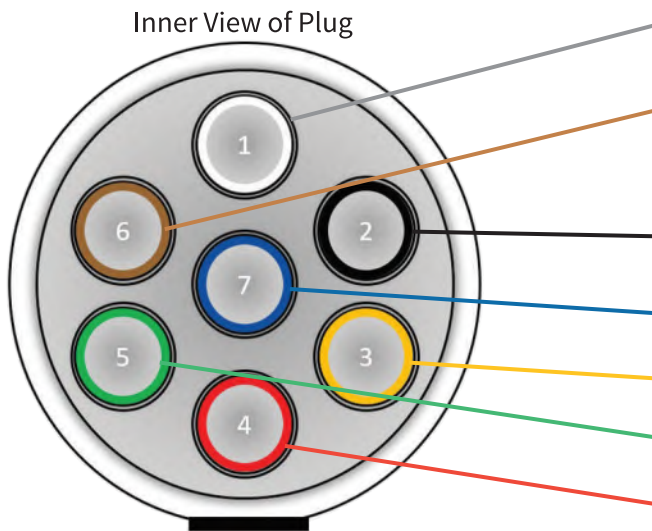

Ground connected to chassis | Toprak Şasi bağlantısı

Right-hand rear position and marker lights and rear-
registration-plate illumination device | SAĞ arka lamba,
pozisyon, işaret lambaları ve plaka aydınlatma

Left-hand rear position and marker lights and rear-
registration-plate illumination device | SOL arka lamba,
pozisyon, işaret lambaları ve plaka aydınlatma

Trailer brake control | Treyler fren kontrolü

Left-hand direction indicator light | SOL sinyal

Right-hand direction indicator light | SAĞ sinyal

Stop lamp | Stop lambası

ISO 3731 S type 24V / 7 pins

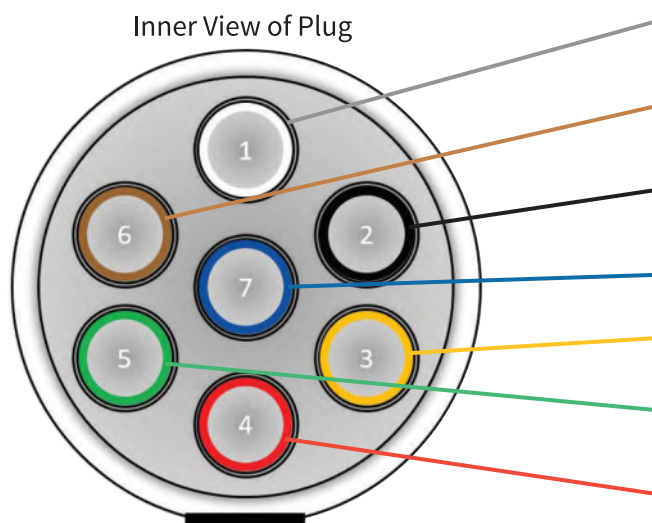

Ground connected to chassis | Toprak Şasi bağlantısı

+24V power supply controlled by ignition switch
Kontakt kontrol +24V

Reversed for future allocation | İhtiyaç duyulabilecek ek
fonksiyonlar için ayrılmış pin

Rear fog lamps | Arka sis lambası

Reversing lamps | Geri vites ışığı

Sensing device with common return | Sensörler için şase
bağlantısı

+24V Permanent | Sabit +24V

WIRING OF SOCKET & PLUGS ACCORDING TO INTERNATIONAL STANDARDS

ISO 7638-1 EBS 24 Volt 7 Pin

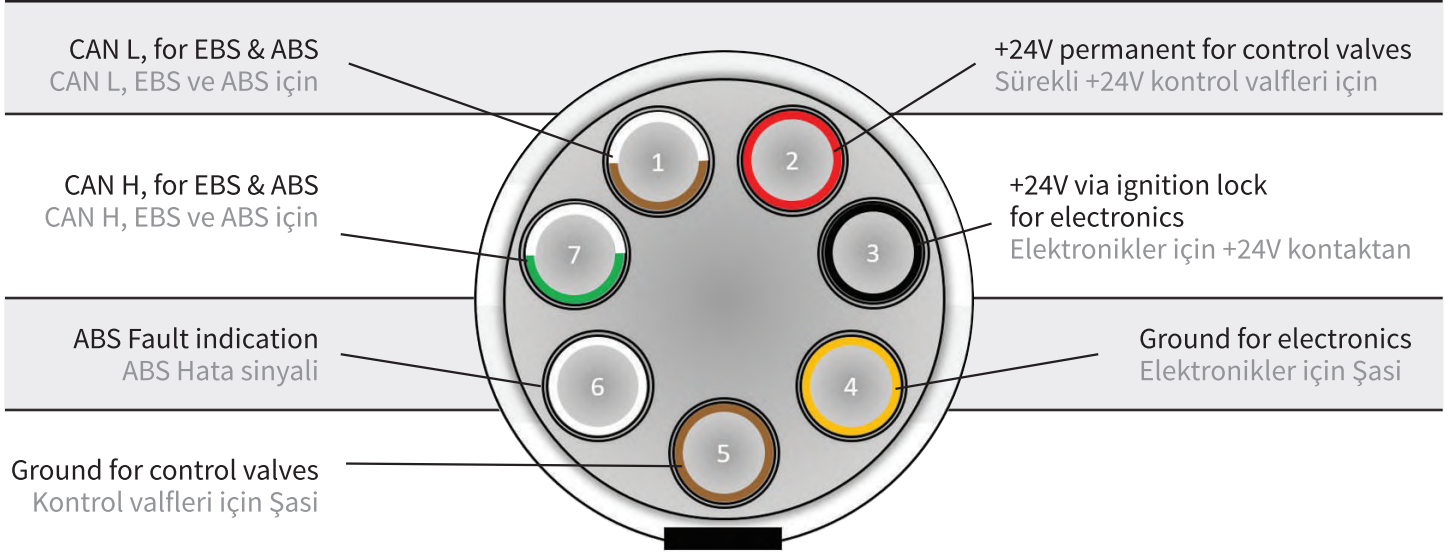

ISO 12098 15-Pin Trailer Connector

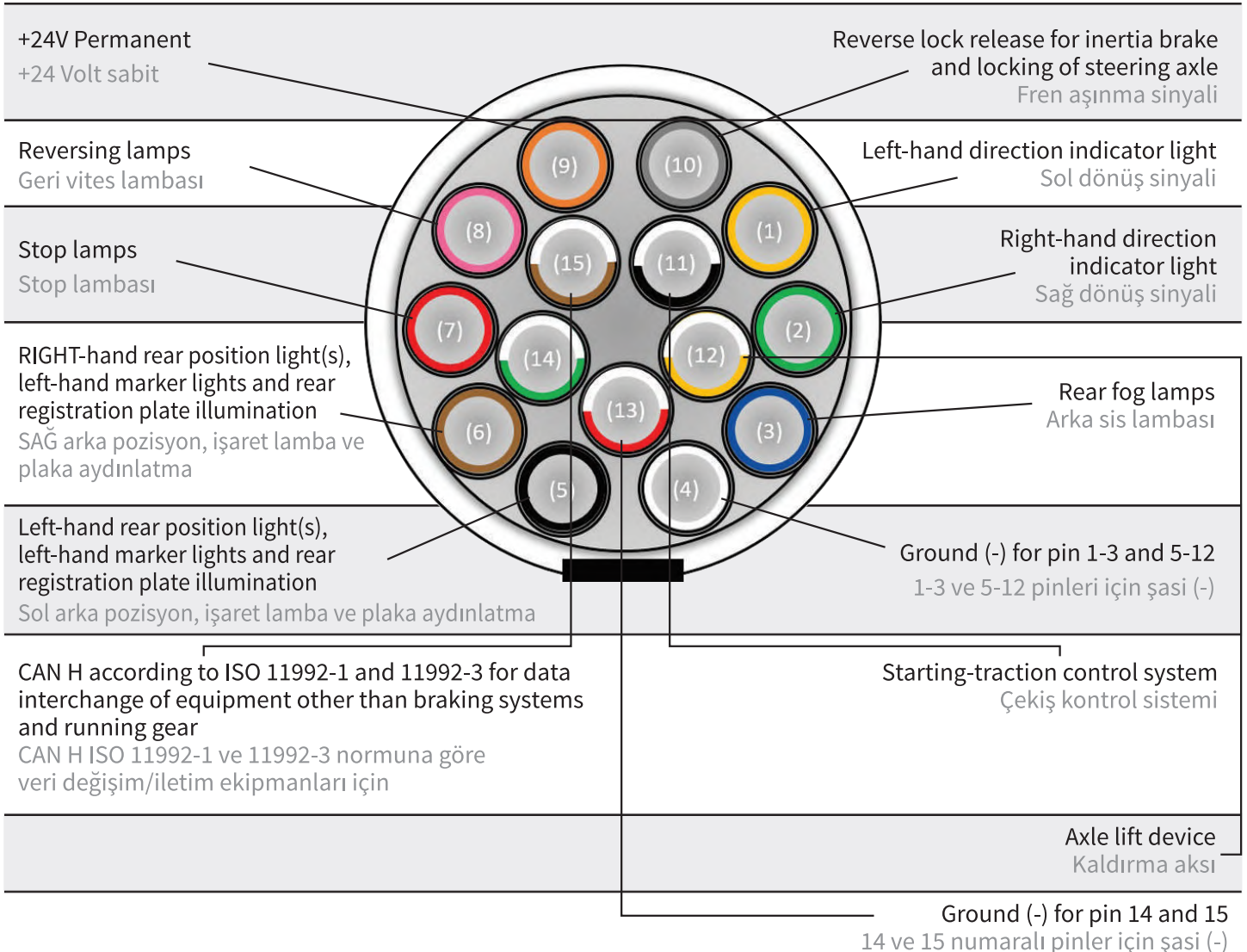

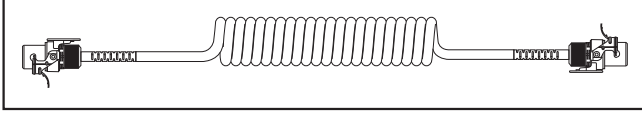
ABS ELECTRICAL CABLE 5 POLES PLUGS
ABS 5 PINLİ, 2 FİŞLİ ELEKTRİK KABLOSU**E4205**

High Temperature Resistant Cable



-40° C Temperature Resistant Cable +125° C

Certificated

- ✓ IP69K
- ✓ ADR ISO 6722
- ✓ ADR ISO 14572
- ✓ ISO 7638
- ✓ ADR/GGVS



Product Speciality Ürün Özelliği	Electric Braking System Coil Cable	Elektrikli Fren Sistemleri için Spiral Elektrik Kablosu
Voltage Compatability Voltaj Uyumluluğu	24V	24V
Wire Cross-Section mm ² Kablo Kesitleri mm ²	2x4 + 3x1,5	2x4 + 3x1,5
Protection Koruma	IP69K	IP69K
Material Hammadde	TPE	TPE
Temperature Res. Sıcaklık Dayanıklılığı	-40° C / +125° C	-40° C / +125° C

		Order Number Sipariş Kodu		
Variants Değişenler	Crimp Pins Sıkmalı Pinli Screw Pins Vidalı Pinli	E4205FH30 E4205FH30FK	E4205FH35 E4205FH35FK	E4205FH40 E4205FH40FK
	Turns / Outer Diameter Sarımlar Sayısı / Dış Çap	14 / 86 mm	17 / 86 mm	19 / 86 mm
	Max. Working Length Maks. Çalışma Boyu	3,5m	4m	4,5m
		15 pcs Adet 38x78x18 cm		

E4207

EBS ELECTRICAL CABLE 7 POLES PLUGS EBS 7 PİNLİ, 2 FİŞLİ ELEKTRİK KABLOSU

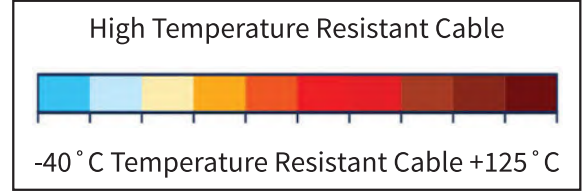
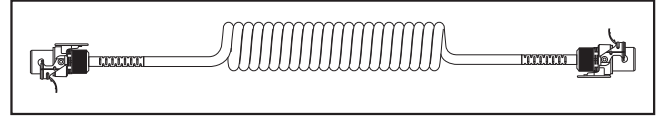
Certificated



- ✓ IP69K
- ✓ ADR ISO 6722
- ✓ ADR ISO 14572
- ✓ ISO 7638
- ✓ ADR/GGVS

Product Speciality Ürün Özelliği	Electric Braking System Coil Cable	Elektrikli Fren Sistemleri için Spiral Elektrik Kablosu
Voltage Compatability Voltaj Uyumluluğu	24V	24V
Wire Cross-Section mm ² Kablo Kesitleri mm ²	2x4 + 5x1,5	2x4 + 5x1,5
Protection Koruma	IP69K	IP69K
Material Hammadde	TPE	TPE
Temperature Res. Sıcaklık Dayanıklılığı	-40° C/ +125° C	-40° C/ +125° C

		Order Number Sipariş Kodu		
Variants Değişenler	Crimp Pins Sıkmalı Pinli Screw Pins Vidalı Pinli	E4207FH30 E4207FH30FK	E4207FH35 E4207FH35FK	E4207FH40 E4207FH40FK
	Turns / Outer Diameter Sarımlar Sayısı / Dış Çap	13 / 90 mm	16 / 90 mm	18 / 90 mm
	Max. Working Length Maks. Çalışma Boyu	3,5m	4m	4,5m
		15 pcs Adet 38x78x18 cm		

ELECTRICAL CABLE TWO 15 POLES 15 CONNECTION PLUGS
15 PİNLİ, 15 BAĞLANTILI, 2 FİŞLİ ELEKTRİK KABLOSU

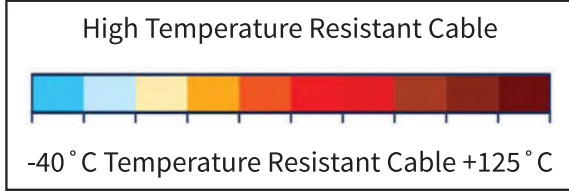
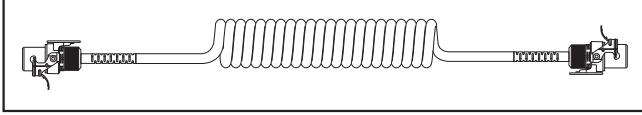
E4215



Certificated



- ✓ IP69K
- ✓ ADR ISO 6722
- ✓ ADR ISO 14572
- ✓ ISO 12098
- ✓ ADR/GGVS



Product Speciality Ürün Özelliği	Electric Braking System Coil Cable	Elektrikli Fren Sistemleri için Spiral Elektrik Kablosu
Voltage Compatability Voltaj Uyumluluğu	24V	24V
Wire Cross-Section mm ² Kablo Kesitleri mm ²	3x2,5 + 12x1,5	3x2,5 + 12x1,5
Protection Koruma	IP69K	IP69K
Material Hammadde	TPE	TPE
Temperature Res. Sıcaklık Dayanıklılığı	-40° C / +125° C	-40° C / +125° C

		Order Number Sipariş Kodu		
Variants Değişenler	Crimp Pins Sıkmalı Pinli Screw Pins Vidalı Pinli	E4215FH30 E4215FH30FK	E4215FH35 E4215FH35FK	E4215FH40 E4215FH40FK
	Turns / Outer Diameter Sarımlar Sayısı / Dış Çap	11 / 115 mm	13 / 115 mm	15 / 115 mm
	Max. Working Length Maks. Çalışma Boyu	3,5m	4m	4,5m
		15 pcs Adet 38x78x18 cm		

E4415

ADAPTER DOUBLE CABLE 15 POLES 13 CONNECTION PLUGS
7 POLES N-TYPE OVER MOLDED PLUG / 7 POLES S-TYPE OVER MOLDED PLUG
15 PİNLİ, 13 BAĞLANTILI, ÇİFT ADAPTÖR KABLOSU
7 PİNLİ N-TİP ENJEKSİYON BASKILI FİŞ/7 PİNLİ S-TİP ENJEKSİYON BASKILI FİŞ

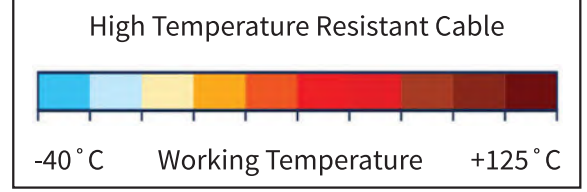
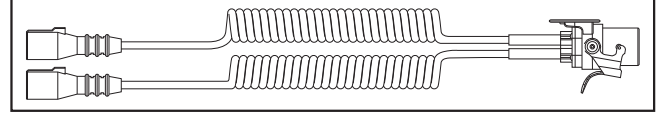

Certificated



- ✓ IP69K
- ✓ ADR ISO 6722
- ✓ ADR ISO 14572
- ✓ ISO 1185
- ✓ ISO 3731
- ✓ ISO 12098

Product Speciality Ürün Özelliği	Electric Braking System Coil Cable	Elektrikli Fren Sistemleri için Spiral Elektrik Kablosu
Voltage Compatability Voltaj Uyumluluğu	24V	24V
Wire Cross-Section mm ² Kablo Kesitleri mm ²	2(6x1 + 1x1,5)	2(6x1 + 1x1,5)
Protection Koruma	IP69K	IP69K
Material Hammadde	TPE	TPE
Temperature Res. Sıcaklık Dayanıklılığı	-40° C / +125° C	-40° C / +125° C

Variants Değişenler	Order Number Sipariş Kodu	E4415FH3U30	E4415FH3U35	E4415FH3U40
	Turns / Outer Diameter Sarımlar Sayısı / Dış Çap	27 / 52 mm	34 / 52 mm	38 / 52 mm
	Max. Working Length Maks. Çalışma Boyu	3,5m	4m	4,5m
		15 pcs Adet 38x78x18 cm		

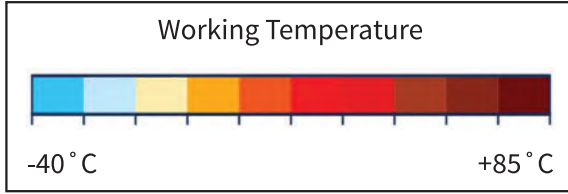
ABS ELECTRICAL CABLE 5 POLES PLUGS
ABS 5 PINLİ, 2 FİŞLİ ELEKTRİK KABLOSU**E4205****Certificated**

- ✓ IP69K
- ✓ ADR ISO 6722
- ✓ ADR ISO 14572
- ✓ ISO 7638
- ✓ ADR/GGVS

Product Speciality Ürün Özelliği	Electric Braking System Coil Cable	Elektrikli Fren Sistemleri için Spiral Elektrik Kablosu
Voltage Compatability Voltaj Uyumluluğu	24V	24V
Wire Cross-Section mm ² Kablo Kesitleri mm ²	2x4 + 3x1,5	2x4 + 3x1,5
Protection Koruma	IP69K	IP69K
Material Hammadde	TPU	TPU
Temperature Res. Sıcaklık Dayanıklılığı	-40 °C / +85 °C	-40 °C / +85 °C

		Order Number Sipariş Kodu		
Variants Değişenler	Crimp Pins Sıkmalı Pinli Screw Pins Vidalı Pinli	E4205F30 E4205F30FK	E4205F35 E4205F35FK	E4205F40 E4205F40FK
	Turns / Outer Diameter Sarımlar Sayısı / Dış Çap	26 / 50 mm	31 / 50 mm	36 / 50 mm
	Max. Working Length Maks. Çalışma Boyu	3,5m	4m	4,5m
		15 pcs Adet 38x78x18 cm		

E4207

EBS ELECTRICAL CABLE 7 POLES PLUGS EBS 7 PİNLİ, 2 FİŞLİ ELEKTRİK KABLOSU

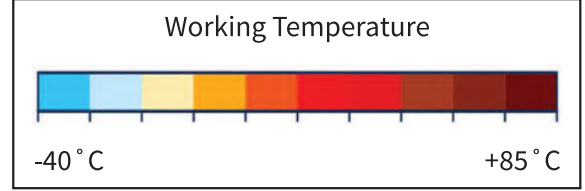
Certificated

 IP69K
 ADR ISO 6722
 ADR ISO 14572
 ISO 7638
 ADR/GGVS

Product Speciality Ürün Özelliği	Electric Braking System Coil Cable	Elektrikli Fren Sistemleri için Spiral Elektrik Kablosu
Voltage Compatability Voltaj Uyumluluğu	24V	24V
Wire Cross-Section mm ² Kablo Kesitleri mm ²	2x4 + 5x1,5	2x4 + 5x1,5
Protection Koruma	IP69K	IP69K
Material Hammadde	TPU	TPU
Temperature Res. Sıcaklık Dayanıklılığı	-40 °C / +85 °C	-40 °C / +85 °C

		Order Number Sipariş Kodu		
Variants Değişenler	Crimp Pins Sıkmalı Pinli Screw Pins Vidalı Pinli	E4207F30 E4207F30FK	E4207F35 E4207F35FK	E4207F40 E4207F40FK
	Turns / Outer Diameter Sarımlar Sayısı / Dış Çap	26 / 52 mm	31 / 52 mm	36 / 52 mm
	Max. Working Length Maks. Çalışma Boyu	3,5m	4m	4,5m
		15 pcs Adet 38x78x18 cm		

ELECTRICAL CABLE TWO 15 POLES 15 CONNECTION PLUGS
15 PİNLİ, 15 BAĞLANTILI, 2 FİŞLİ ELEKTRİK KABLOSU

E4215

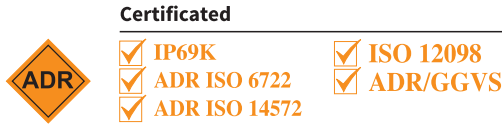
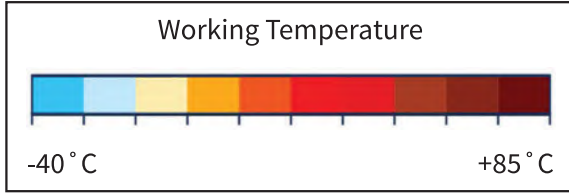

Product Speciality Ürün Özelliği	Electric Braking System Coil Cable	Elektrikli Fren Sistemleri için Spiral Elektrik Kablosu
Voltage Compatability Voltaj Uyumluluğu	24V	24V
Wire Cross-Section mm ² Kablo Kesitleri mm ²	3x2,5 + 12x1,5	3x2,5 + 12x1,5
Protection Koruma	IP69K	IP69K
Material Hammadde	TPU	TPU
Temperature Res. Sıcaklık Dayanıklılığı	-40 °C / +85 °C	-40 °C / +85 °C

		Order Number Sipariş Kodu		
Variants Değişenler	Crimp Pins Sıkmalı Pinli Screw Pins Vidalı Pinli	E4215F30 E4215F30FK	E4215F35 E4215F35FK	E4215F40 E4215F40FK
	Turns / Outer Diameter Sarımlar Sayısı / Dış Çap	19 / 67 mm	22 / 67 mm	25 / 67 mm
	Max. Working Length Maks. Çalışma Boyu	3,5m	4m	4,5m
		12 pcs Adet	38x78x18 cm	10 pcs Adet

E4415

ADAPTER DOUBLE CABLE 15 POLES 13 CONNECTION PLUGS
7 POLES N-TYPE METAL PLUG / 7 POLES S-TYPE METAL PLUG
15 PİNLİ, 13 BAĞLANTILI, ÇİFT ADAPTÖR KABLOSU
7 PİNLİ N-TİP METAL FİŞ / 7 PİNLİ S-TİP METAL FİŞ

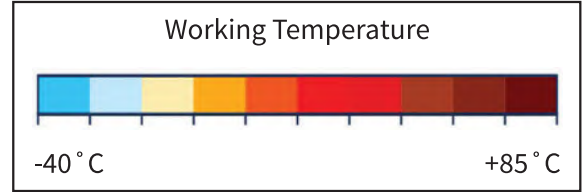

Certificated



- ✓ IP69K
- ✓ ADR ISO 6722
- ✓ ADR ISO 14572
- ✓ ISO 1185
- ✓ ISO 3731
- ✓ ISO 12098

Product Speciality Ürün Özelliği	Electric Braking System Coil Cable	Elektrikli Fren Sistemleri için Spiral Elektrik Kablosu
Voltage Compatability Voltaj Uyumluluğu	24V	24V
Wire Cross-Section mm ² Kablo Kesitleri mm ²	2(6x1 + 1x1,5)	2(6x1 + 1x1,5)
Protection Koruma	IP69K	IP69K
Material Hammadde	TPU	TPU
Temperature Res. Sıcaklık Dayanıklılığı	-40 °C / +85 °C	-40 °C / +85 °C

Variants Değişenler	Order Number Sipariş Kodu	E4415F3M30	E4415F3M35	E4415F3M40
	Turns / Outer Diameter Sarımlar Sayısı / Dış Çap	27 / 47 mm	33 / 47 mm	38 / 47 mm
	Max. Working Length Maks. Çalışma Boyu	3,5m	4m	4,5m
		15 pcs Adet 38x78x18 cm		

**ADAPTER DOUBLE CABLE 15 POLES 13 CONNECTION PLUGS
7 POLES N-TYPE PLASTIC PLUG / 7 POLES S-TYPE PLASTIC PLUG
15 PİNLİ, 13 BAĞLANTILI, ÇİFT ADAPTÖR KABLOSU
7 PİNLİ N-TİP PLASTİK FİŞ / 7 PİNLİ S-TİP PLASTİK FİŞ**

E4415

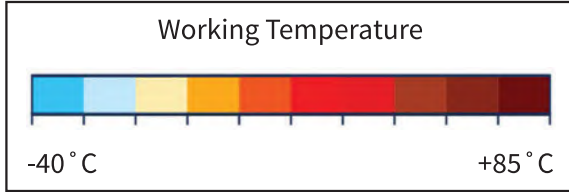

Certificated



- ✓ IP69K
- ✓ ADR ISO 6722
- ✓ ADR ISO 14572
- ✓ ISO 1185
- ✓ ISO 3731
- ✓ ISO 12098

Product Speciality Ürün Özelliği	Electric Braking System Coil Cable	Elektrikli Fren Sistemleri için Spiral Elektrik Kablosu
Voltage Compatability Voltaj Uyumluluğu	24V	24V
Wire Cross-Section mm ² Kablo Kesitleri mm ²	2(6x1 + 1x1,5)	2(6x1 + 1x1,5)
Protection Koruma	IP69K	IP69K
Material Hammadde	TPU	TPU
Temperature Res. Sıcaklık Dayanıklılığı	-40 °C / +85 °C	-40 °C / +85 °C

Variants Değişenler	Order Number Sipariş Kodu	E4415F3P30	E4415F3P35	E4415F3P40
	Turns / Outer Diameter Sarımlar Sayısı / Dış Çap	27 / 47 mm	33 / 47 mm	38 / 47 mm
	Max. Working Length Maks. Çalışma Boyu	3,5m	4m	4,5m
		15 pcs Adet 38x78x18 cm		

E4415

ADAPTER DOUBLE CABLE 15 POLES 13 CONNECTION PLUGS
7 POLES N-TYPE OVER MOLDED PLUG / 7 POLES S-TYPE OVER MOLDED PLUG
15 PİNLİ, 13 BAĞLANTILI, ÇİFT ADAPTÖR KABLOSU
7 PİNLİ N-TİP ENJEKSİYON BASKILI FİŞ/7 PİNLİ S-TİP ENJEKSİYON BASKILI FİŞ

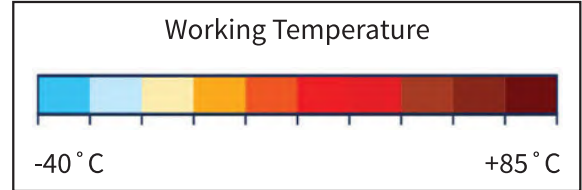

Certificated



- ✓ IP69K
- ✓ ADR ISO 6722
- ✓ ADR ISO 14572
- ✓ ISO 1185
- ✓ ISO 3731
- ✓ ISO 12098

Product Speciality Ürün Özelliği	Electric Braking System Coil Cable	Elektrikli Fren Sistemleri için Spiral Elektrik Kablosu
Voltage Compatability Voltaj Uyumluluğu	24V	24V
Wire Cross-Section mm ² Kablo Kesitleri mm ²	2(6x1 + 1x1,5)	2(6x1 + 1x1,5)
Protection Koruma	IP69K	IP69K
Material Hammadde	TPU	TPU
Temperature Res. Sıcaklık Dayanıklılığı	-40 °C / +85 °C	-40 °C / +85 °C

Variants Değişenler	Order Number Sipariş Kodu	E4415F3U30	E4415F3U35	E4415F3U40
	Turns / Outer Diameter Sarımlar Sayısı / Dış Çap	27 / 47 mm	33 / 47 mm	38 / 47 mm
	Max. Working Length Maks. Çalışma Boyu	3,5m	4m	4,5m
		15 pcs Adet 38x78x18 cm		

ADAPTER DOUBLE CABLE 15 POLES 9 CONNECTION PLUGS
7 POLES N-TYPE PLASTIC PLUG / 7 POLES S-TYPE PLASTIC PLUG
15 PİNLİ, 9 BAĞLANTILI, ÇİFT ADAPTÖR KABLOSU
7 PİNLİ N-TİP PLASTİK FİŞ / 7 PİNLİ S-TİP PLASTİK FİŞ

E4415

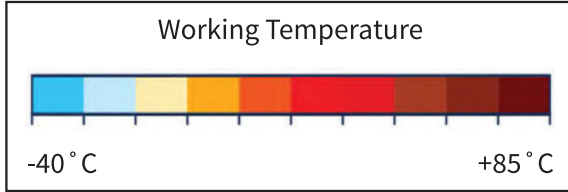

Certificated



- ✓ IP69K
- ✓ ADR ISO 6722
- ✓ ADR ISO 14572
- ✓ ISO 1185
- ✓ ISO 3731
- ✓ ISO 12098

Product Speciality Ürün Özelliği	Electric Braking System Coil Cable	Elektrikli Fren Sistemleri için Spiral Elektrik Kablosu
Voltage Compatability Voltaj Uyumluluğu	24V	24V
Wire Cross-Section mm ² Kablo Kesitleri mm ²	2(6x1 + 1x1,5)	2(6x1 + 1x1,5)
Protection Koruma	IP69K	IP69K
Material Hammadde	TPU	TPU
Temperature Res. Sıcaklık Dayanıklılığı	-40 °C / +85 °C	-40 °C / +85 °C

Variants Değişenler	Order Number Sipariş Kodu	E4415F9P30	E4415F9P35	E4415F9P40
	Turns / Outer Diameter Sarımlar Sayısı / Dış Çap	27 / 47 mm	33 / 47 mm	38 / 47 mm
	Max. Working Length Maks. Çalışma Boyu	3,5m	4m	4,5m
		15 pcs Adet 38x78x18 cm		

E4415

ADAPTER DOUBLE CABLE 15 POLES 9 CONNECTION PLUGS
7 POLES N-TYPE OVER MOLDED PLUG / 7 POLES S-TYPE OVER MOLDED PLUG
15 PİNLİ, 9 BAĞLANTILI, ÇİFT ADAPTÖR KABLOSU
7 PİNLİ N-TİP ENJEKSİYON BASKILI FİŞ/7 PİNLİ S-TİP ENJEKSİYON BASKILI FİŞ

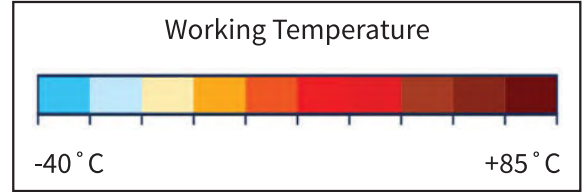

Certificated



- ✓ IP69K
- ✓ ADR ISO 6722
- ✓ ADR ISO 14572
- ✓ ISO 1185
- ✓ ISO 3731
- ✓ ISO 12098

Product Speciality Ürün Özelliği	Electric Braking System Coil Cable	Elektrikli Fren Sistemleri için Spiral Elektrik Kablosu
Voltage Compatability Voltaj Uyumluluğu	24V	24V
Wire Cross-Section mm ² Kablo Kesitleri mm ²	2(6x1 + 1x1,5)	2(6x1 + 1x1,5)
Protection Koruma	IP69K	IP69K
Material Hammadde	TPU	TPU
Temperature Res. Sıcaklık Dayanıklılığı	-40 °C / +85 °C	-40 °C / +85 °C

Variants Değişenler	Order Number Sipariş Kodu	E4415F9U30	E4415F9U35	E4415F9U40
	Turns / Outer Diameter Sarımlar Sayısı / Dış Çap	27 / 47 mm	33 / 47 mm	38 / 47 mm
	Max. Working Length Maks. Çalışma Boyu	3,5m	4m	4,5m
		15 pcs Adet 38x78x18 cm		

ELECTRICAL CABLE WITH 7 POLES PLUG (24V) N/S-TYPE
7 PİNLİ, İKİ PLASTİK FİŞLİ N/S-TİP (24V) ELEKTRİK KABLOSU

E3853

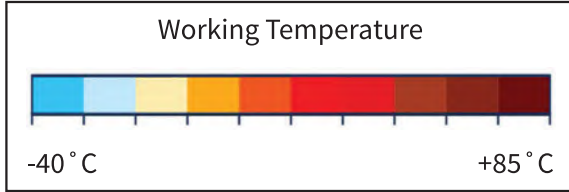

Certificated

- ✓ ADR ISO 6722 ✓ ISO 3731
- ✓ ADR ISO 14572 ✓ ISO 1185

Product Speciality Ürün Özelliği	Electric Braking System Coil Cable	Elektrikli Fren Sistemleri için Spiral Elektrik Kablosu
Voltage Compatability Voltaj Uyumluluğu	24V	24V
Wire Cross-Section mm ² Kablo Kesitleri mm ²	6x1 + 1x1,5	6x1 + 1x1,5
Material Hammadde	TPU	TPU
Temperature Res. Sıcaklık Dayanıklılığı	-40 °C / +85 °C	-40 °C / +85 °C

Variants Değişenler	Order Number Sipariş Kodu	N Type S Type	N Tip S Tip	EN3853FP30 ES3853FP30	EN3853FP35 ES3853FP35	EN3853FP40 ES3853FP40
	Turns / Outer Diameter Sarımlar Sayısı / Dış Çap			27 / 47 mm	33 / 47 mm	38 / 47 mm
	Max. Working Length Maks. Çalışma Boyu			3,5m	4m	4,5m
				30 pcs Adet	38x78x18 cm	25 pcs Adet 38x78x18 cm

E3853

ELECTRICAL CABLE WITH 7 POLES OVER MOLDED PLASTIC PLUG
(24V) N/S TYPE
7 PİNLİ, ENJEKSİYON BASKILI, İKİ FİŞLİ ELEKTRİK KABLOSU
N/S TİP (24V)

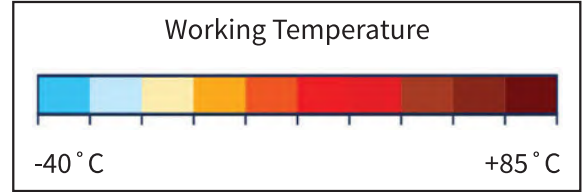

Certificated

- ✓ ADR ISO 6722
- ✓ ADR ISO 14572
- ✓ ISO 1185
- ✓ ISO 3731

Product Speciality Ürün Özelliği	Electric Braking System Coil Cable	Elektrikli Fren Sistemleri için Spiral Elektrik Kablosu
Voltage Compatability Voltaj Uyumluluğu	24V	24V
Wire Cross-Section mm ² Kablo Kesitleri mm ²	6x1 + 1x1,5	6x1 + 1x1,5
Material Hammadde	TPU	TPU
Temperature Res. Sıcaklık Dayanıklılığı	-40 °C / +85 °C	-40 °C / +85 °C

Variants Değişenler	Order Number Sipariş Kodu	N Type N Tip S Type S Tip	EN3853FU30 ES3853FU30	EN3853FU35 ES3853FU35	EN3853FU40 ES3853FU40
	Turns / Outer Diameter Sarımlar Sayısı / Dış Çap		27 / 47 mm	33 / 47 mm	38 / 47 mm
	Max. Working Length Maks. Çalışma Boyu		3,5m	4m	4,5m
			30 pcs Adet	38x78x18 cm	25 pcs Adet

**ELECTRICAL CABLE WITH 7 POLES PLUG WITH ONE END HOOKED SPRING
(24V) N/S TYPE**

E3853

7 PİNLİ, BİR UCU KANCALI YAYLI, 2 METAL FİŞLİ ELEKTRİK KABLOSU
(24V) N/S TİP

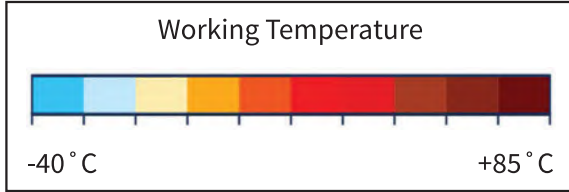

Certificated

- ✓ ADR ISO 6722
- ✓ ADR ISO 14572
- ✓ ISO 3731
- ✓ ISO 1185

Product Speciality Ürün Özelliği	Electric Braking System Coil Cable	Elektrikli Fren Sistemleri için Spiral Elektrik Kablosu
Voltage Compatability Voltaj Uyumluluğu	24V	24V
Wire Cross-Section mm ² Kablo Kesitleri mm ²	6x1 + 1x1,5	6x1 + 1x1,5
Material Hammadde	TPU	TPU
Temperature Res. Sıcaklık Dayanıklılığı	-40 °C / +85 °C	-40 °C / +85 °C

Variants Değişenler	Order Number Sipariş Kodu	N Type S Type	N Tip S Tip	EN3853F1WM30 ES3853F1WM30	EN3853F1WM35 ES3853F1WM35	EN3853F1WM40 ES3853F1WM40
	Turns / Outer Diameter Sarımlar Sayısı / Dış Çap			27 / 47 mm	33 / 47 mm	38 / 47 mm
	Max. Working Length Maks. Çalışma Boyu			3,5m	4m	4,5m
				30 pcs Adet	38x78x18 cm	25 pcs Adet 38x78x18 cm

E3853

ELECTRICAL CABLE WITH 7 POLES PLUG WITH BOTH END HOOKED SPRING
(24V) N/S TYPE
7 PİNLİ, İKİ UCU KANCALI YAYLI, 2 METAL FİŞLİ ELEKTRİK KABLOSU
(24V) N/S TİP

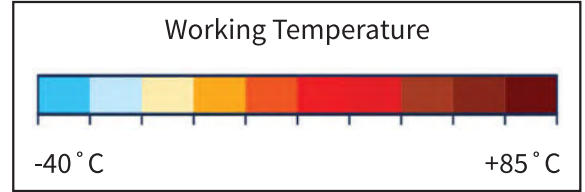

Certificated

- ✓ ADR ISO 6722
- ✓ ADR ISO 14572
- ✓ ISO 1185
- ✓ ISO 3731

Product Speciality Ürün Özelliği	Electric Braking System Coil Cable	Elektrikli Fren Sistemleri için Spiral Elektrik Kablosu
Voltage Compatability Voltaj Uyumluluğu	24V	24V
Wire Cross-Section mm ² Kablo Kesitleri mm ²	6x1 + 1x1,5	6x1 + 1x1,5
Material Hammadde	TPU	TPU
Temperature Res. Sıcaklık Dayanıklılığı	-40 °C / +85 °C	-40 °C / +85 °C

Variants Değişenler	Order Number Sipariş Kodu	N Type N Tip S Type S Tip	EN3853F2WM30 ES3853F2WM30	EN3853F2WM35 ES3853F2WM35	EN3853F2WM40 ES3853F2WM40
	Turns / Outer Diameter Sarımlar Sayısı / Dış Çap			27 / 47 mm	33 / 47 mm
Max. Working Length Maks. Çalışma Boyu			3,5m	4m	4,5m
			30 pcs Adet	38x78x18 cm	25 pcs Adet 38x78x18 cm

ELECTRICAL CABLE WITH 7 POLES METAL PLUG (24V) N/S TYPE
7 PİNLİ, 2 METAL FİŞLİ N/S TİP (24V) ELEKTRİK KABLOSU

E3853

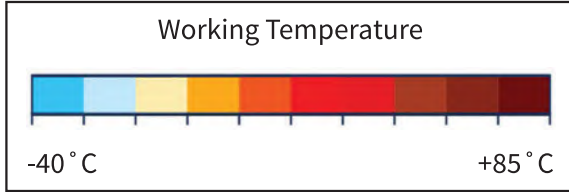

Certificated

- ✓ ADR ISO 6722 ✓ ISO 3731
- ✓ ADR ISO 14572 ✓ ISO 1185

Product Speciality Ürün Özelliği	Electric Braking System Coil Cable	Elektrikli Fren Sistemleri için Spiral Elektrik Kablosu
Voltage Compatability Voltaj Uyumluluğu	24V	24V
Wire Cross-Section mm ² Kablo Kesitleri mm ²	6x1 + 1x1,5	6x1 + 1x1,5
Material Hammadde	TPU	TPU
Temperature Res. Sıcaklık Dayanıklılığı	-40 °C / +85 °C	-40 °C / +85 °C

Variants Değişenler	Order Number Sipariş Kodu	N Type N Tip S Type S Tip	EN3853FM30 ES3853FM30	EN3853FM35 ES3853FM35	EN3853FM40 ES3853FM40
	Turns / Outer Diameter Sarımlar Sayısı / Dış Çap		27 / 47 mm	33 / 47 mm	38 / 47 mm
	Max. Working Length Maks. Çalışma Boyu		3,5m	4m	4,5m
			30 pcs Adet	38x78x18 cm	25 pcs Adet

E3862

ELECTRICAL CABLE WITH 7 POLES METAL PLUG (12V / 24V) S-TYPE
7 PİNLİ, 2 METAL FİŞLİ ELEKTRİK KABLOSU (12V / 24V) S-TİP

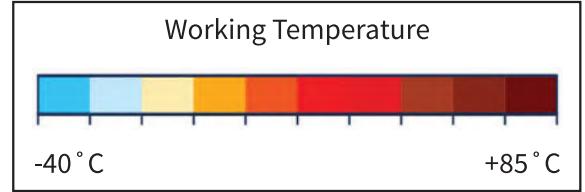
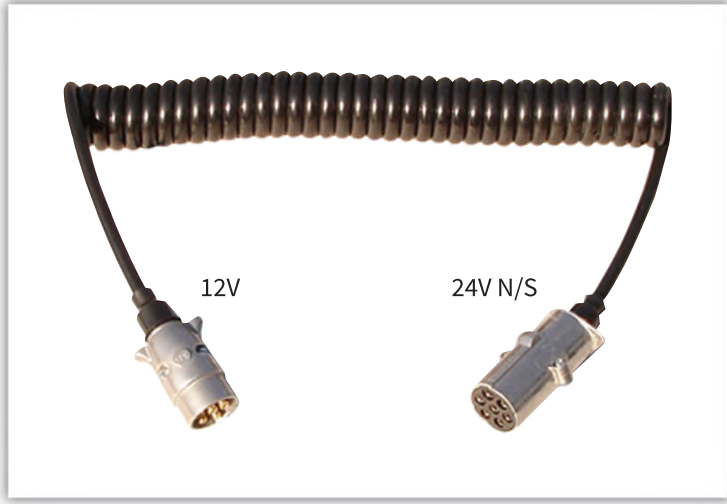
Certificated

- ✓ ADR ISO 6722
- ✓ ADR ISO 14572

- ✓ ISO 1724
- ✓ ISO 3731
- ✓ ISO 1185

Product Speciality Ürün Özelliği	Electric Braking System Coil Cable	Elektrikli Fren Sistemleri için Spiral Elektrik Kablosu
Voltage Compatability Voltaj Uyumluluğu	12V - 12/24V	12V - 12/24V
Wire Cross-Section mm ² Kablo Kesitleri mm ²	6x1 + 1x1,5	6x1 + 1x1,5
Material Hammadde	TPU	TPU
Temperature Res. Sıcaklık Dayanıklılığı	-40 °C / +85 °C	-40 °C / +85 °C

Variants Değişenler	Order Number Sipariş Kodu	N Type N Tip S Type S Tip	EN3862FM30 ES3862FM30	EN3862FM35 ES3862FM35	EN3862FM40 ES3862FM40
	Turns / Outer Diameter Sarım Sayısı / Dış Çap		27 / 47 mm	33 / 47 mm	38 / 47 mm
	Max. Working Length Maks. Çalışma Boyu		3,5m	4m	4,5m
			30 pcs Adet	38x78x18 cm	25 pcs Adet

ELECTRICAL CABLE WITH 7 POLES PLASTIC PLUG (12V / 24V) S-TYPE
7 PİNLİ, TOZ KORUMA LASTİKLİ, 2 PLASTİK FİŞLİ ELEKTRİK KABLOSU
(12V / 24V) S-TİP

E3862

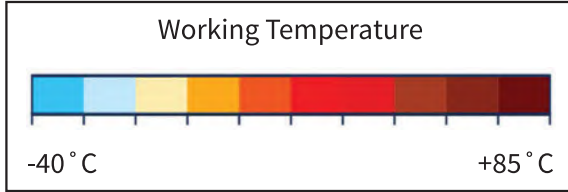

Certificated

- ✓ ADR ISO 6722
- ✓ ADR ISO 14572
- ✓ ISO 1724
- ✓ ISO 3731
- ✓ ISO 1185

Product Speciality Ürün Özelliği	Electric Braking System Coil Cable	Elektrikli Fren Sistemleri için Spiral Elektrik Kablosu
Voltage Compatability Voltaj Uyumluluğu	12V - 12/24V	12V - 12/24V
Wire Cross-Section mm ² Kablo Kesitleri mm ²	6x1 + 1x1,5	6x1 + 1x1,5
Material Hammadde	TPU	TPU
Temperature Res. Sıcaklık Dayanıklılığı	-40 °C / +85 °C	-40 °C / +85 °C

Variants Değişenler	Order Number Sipariş Kodu	N Type N Tip S Type S Tip	EN3862FP30 ES3862FP30	EN3862FP35 ES3862FP35	EN3862FP40 ES3862FP40
	Turns / Outer Diameter Sarım Sayısı / Dış Çap		27 / 47 mm	33 / 47 mm	38 / 47 mm
	Max. Working Length Maks. Çalışma Boyu		3,5m	4m	4,5m
			30 pcs Adet	38x78x18 cm	25 pcs Adet 38x78x18 cm

E3853

ELECTRICAL CABLE WITH 7 POLES METAL PLUG (24V) N/S TYPE
7 PİNLİ, 2 METAL FİŞLİ N/S TİP (24V) ELEKTRİK KABLOSU

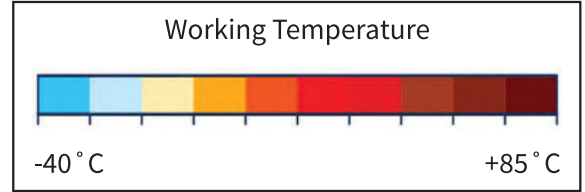

Certificated

- ✓ ADR ISO 6722
- ✓ ADR ISO 14572
- ✓ ISO 3731
- ✓ ISO 1185

Product Speciality Ürün Özelliği	Electric Braking System Coil Cable	Elektrikli Fren Sistemleri için Spiral Elektrik Kablosu
Voltage Compatability Voltaj Uyumluluğu	24V	24V
Wire Cross-Section mm ² Kablo Kesitleri mm ²	6x1 + 1x1,5	6x1 + 1x1,5
Material Hammadde	TPU	TPU
Temperature Res. Sıcaklık Dayanıklılığı	-40 °C / +85 °C	-40 °C / +85 °C

Variants Değişenler	Order Number Sipariş Kodu	N Type N Tip S Type S Tip	EN3853FWM30 ES3853FWM30	EN3853FWM35 ES3853FWM35	EN3853FWM40 ES3853FWM40
	Turns / Outer Diameter Sarımlar Sayısı / Dış Çap		27 / 47 mm	33 / 47 mm	38 / 47 mm
	Max. Working Length Maks. Çalışma Boyu		3,5m	4m	4,5m
			30 pcs Adet	38x78x18 cm	25 pcs Adet 38x78x18 cm

ELECTRICAL CABLE WITH 7 POLES METAL DUST SEALED PLUG (12V)
7 PİNLİ, TOZ KORUMA LASTİKLİ, 2 METAL FİŞLİ ELEKTRİK KABLOSU (12V)

E3863

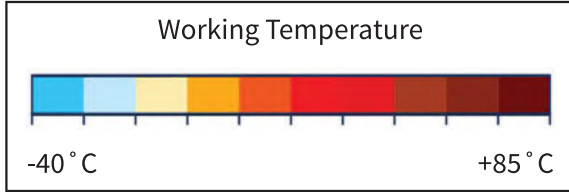

Certificated

- ✓ ADR ISO 6722
- ✓ ADR ISO 14572
- ✓ ISO 1724

Product Speciality Ürün Özelliği	Electric Braking System Coil Cable	Elektrikli Fren Sistemleri için Spiral Elektrik Kablosu
Voltage Compatability Voltaj Uyumluluğu	12V	12V
Wire Cross-Section mm ² Kablo Kesitleri mm ²	6x1 + 1x1,5	6x1 + 1x1,5
Material Hammadde	TPU	TPU
Temperature Res. Sıcaklık Dayanıklılığı	-40 °C / +85 °C	-40 °C / +85 °C

Variants Değişenler	Order Number Sipariş Kodu	E3863FM30	E3863FM35	E3863FM40
	Turns / Outer Diameter Sarımlar Sayısı / Dış Çap	27 / 47 mm	33 / 47 mm	38 / 47 mm
	Max. Working Length Maks. Çalışma Boyu	3,5m	4m	4,5m
		30 pcs Adet	38x78x18 cm	25 pcs Adet 38x78x18 cm

E3863

ELECTRICAL CABLE WITH 7 POLES PLASTIC PLUG (12V)
7 PİNLİ, 2 PLASTİK FİŞLİ ELEKTRİK KABLOSU (12V)

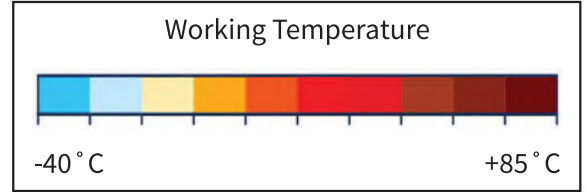

Certificated

ADR ISO 6722

ISO 1724

ADR ISO 14572

Product Speciality Ürün Özelliği	Electric Braking System Coil Cable	Elektrikli Fren Sistemleri için Spiral Elektrik Kablosu
Voltage Compatability Voltaj Uyumluluğu	12V	12V
Wire Cross-Section mm ² Kablo Kesitleri mm ²	6x1 + 1x1,5	6x1 + 1x1,5
Material Hammadde	TPU	TPU
Temperature Res. Sıcaklık Dayanıklılığı	-40 °C / +85 °C	-40 °C / +85 °C

Variants Değişenler	Order Number Sipariş Kodu	E3863FP30	E3863FP35	E3863FP40
	Turns / Outer Diameter Sarım Sayısı / Dış Çap	27 / 47 mm	33 / 47 mm	38 / 47 mm
	Max. Working Length Maks. Çalışma Boyu	3,5m	4m	4,5m
		30 pcs Adet	38x78x18 cm	25 pcs Adet

**HEAVY DUTY ELECTRICAL CABLE WITH 7 POLES BOTH END HOOKED
WITH STRAIGHT SPRING PLUGS (24V)**

EN3864

**7 PİNLİ, İKİ TARAFTAN KANCALI, DÜZ YAYLI, AĞIR İŞ
ELEKTRİK KABLOSU (24V)**

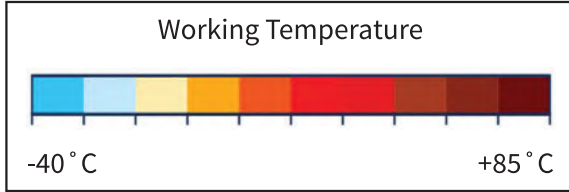

Certificated

- ADR ISO 6722
- ADR ISO 14572

Product Speciality Ürün Özelliği	Electric Braking System Coil Cable	Elektrikli Fren Sistemleri için Spiral Elektrik Kablosu
Voltage Compatability Voltaj Uyumluluğu	24 / 24V	24 / 24V
Wire Cross-Section mm ² Kablo Kesitleri mm ²	6x2 + 1x3	6x2 + 1x3
Material Hammadde	TPU	TPU
Temperature Res. Sıcaklık Dayanıklılığı	-40 °C / +85 °C	-40 °C / +85 °C

Variants Değişenler	Order Number Sipariş Kodu	EN3864FM30	EN3864FM35	EN3864FM40
	Turns / Outer Diameter Sarımlar Sayısı / Dış Çap	12 / 67 mm	16 / 67 mm	19 / 67 mm
	Max. Working Length Maks. Çalışma Boyu	3,5m	4m	4,5m
		12 pcs Adet	38x78x18 cm	10 pcs Adet 38x78x18 cm

7 POLE STANDART TYPE, WITH METAL PLUG ELECTRICAL SPIRAL CABLE
(24V) N-TYPE

7 PİNLİ, STANDART TİP, METAL FİŞLİ SİRİL ELEKTRİK KABLOSU
N-TİP (24V)

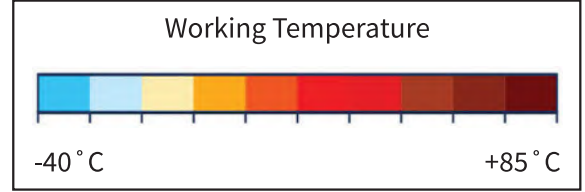
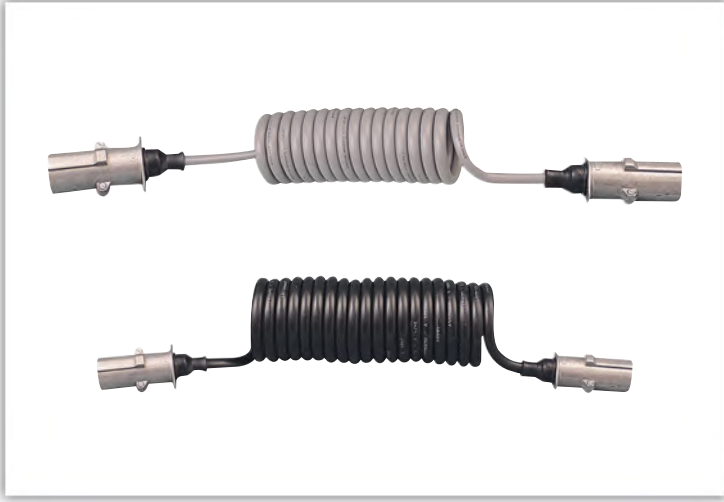

Product Speciality Ürün Özelliği	Electric Braking System Coil Cable	Elektrikli Fren Sistemleri için Siral Elektrik Kablosu
Voltage Compatability Voltaj Uyumluluğu	24 / 24V	24 / 24V
Material Hammadde	PE	PE
Temperature Res. Sıcaklık Dayanıklılığı	-40 °C / +85 °C	-40 °C / +85 °C

		Order Number Sipariş Kodu		
Variants Değişenler	With Plug Fişli	EN3811F	EN3813F	EN3809F
	Without Plug Fişsiz	E3812F	3857F	3808F
	Turns / Outer Diameter Sarımlar Sayısı / Dış Çap	20 / 86 mm	20 / 86 mm	20 / 86 mm
	Max. Working Length Maks. Çalışma Boyu	4,2m	4,2m	4,2m
	Wire Cross-Section mm ² Kablo Kesitleri mm ²	6x1 + 1x1,5	6x0,75 + 1x1	6x0,75 + 1x1
		20 pcs Adet 41x41x41 cm		

7 POLE STANDART TYPE, WITH METAL PLUG ELECTRICAL SPIRAL CABLE
(24V) S-TYPE

7 PİNLİ, STANDART TİP, METAL FİŞLİ SİRAL ELEKTRİK KABLOSU
S-TİP (24V)

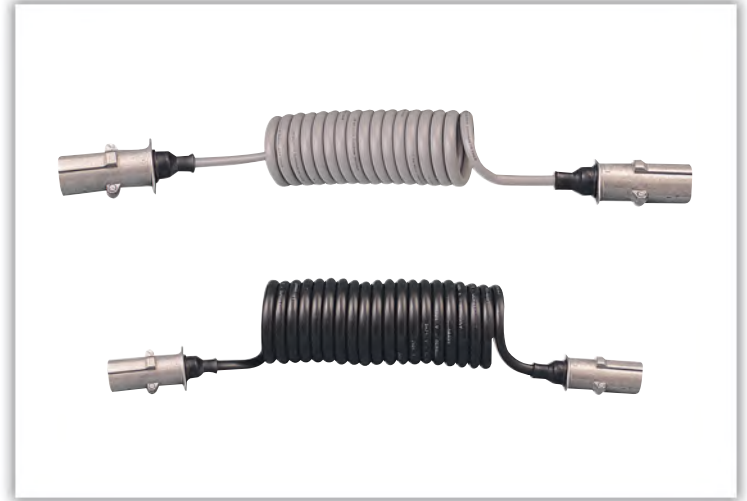
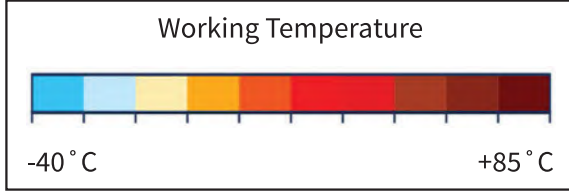

Product Speciality Ürün Özelliği	Electric Braking System Coil Cable	Elektrikli Fren Sistemleri için Siral Elektrik Kablosu
Voltage Compatability Voltaj Uyumluluğu	24 / 24V	24 / 24V
Material Hammadde	PE	PE
Temperature Res. Sıcaklık Dayanıklılığı	-40 ° C / +85 ° C	-40 ° C / +85 ° C

		Order Number Sipariş Kodu		
Variants Değişenler	With Plug Fişli	ES3811F	ES3813F	ES3809F
	Without Plug Fişsiz	E3812F	3857F	3808F
	Turns / Outer Diameter Sarım Sayısı / Dış Çap	20 / 86 mm	20 / 86 mm	20 / 86 mm
	Max. Working Length Maks. Çalışma Boyu	4,2m	4,2m	4,2m
	Wire Cross-Section mm ² Kablo Kesitleri mm ²	6x1 + 1x1,5	6x0,75 + 1x1	6x0,75 + 1x1
		20 pcs Adet 41x41x41 cm		

7 POLE STANDART TYPE, WITH PLASTIC PLUG P.E. ELECTRICAL SPIRAL CABLE (24V)

7 PİNLİ, STANDART TİP, PLASTİK FİŞLİ SİRAL ELEKTRİK KABLOSU (24V)

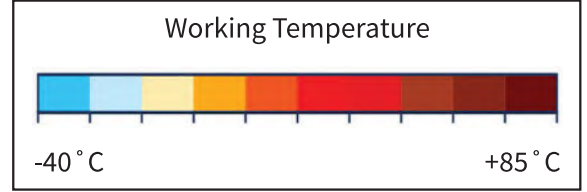
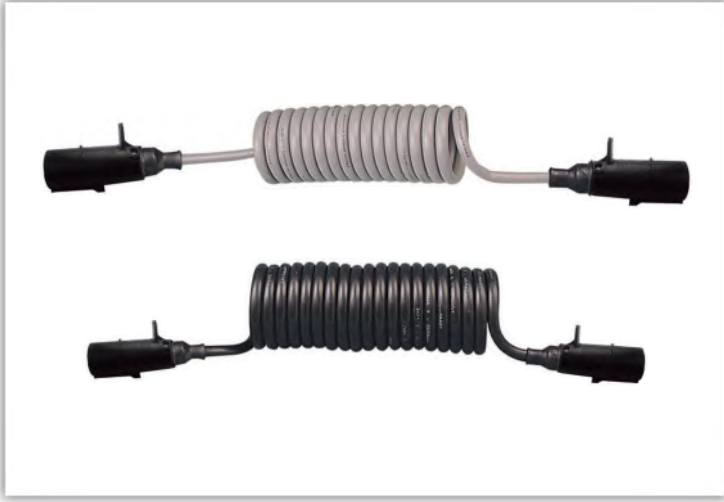

Product Speciality Ürün Özelliği	Electric Braking System Coil Cable	Elektrikli Fren Sistemleri için Siral Elektrik Kablosu
Voltage Compatability Voltaj Uyumluluğu	24 / 24V	24 / 24V
Material Hammadde	PE	PE
Temperature Res. Sıcaklık Dayanıklılığı	-40 ° C / +85 ° C	-40 ° C / +85 ° C

		Order Number Sipariş Kodu		
Variants Değişenler	N Type N Tip S Type S Tip	EN3811FP ES3812FP	EN3813FP ES3857FP	EN3809FP ES3808FP
	Turns / Outer Diameter Sarım Sayısı / Dış Çap	20 / 86 mm	20 / 86 mm	20 / 86 mm
	Max. Working Length Maks. Çalışma Boyu	4,2m	4,2m	4,2m
	Wire Cross-Section mm ² Kablo Kesitleri mm ²	6x1 + 1x1,5	6x0,75 + 1x1	6x0,50 + 1x0,75
		20 pcs Adet 41x41x41 cm		

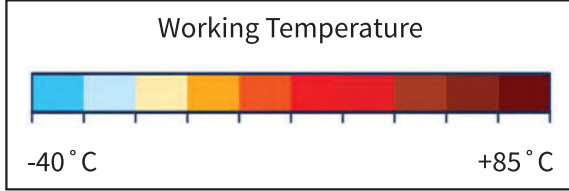
7 POLES ELECTRICAL CABLE
7 PİNLİ ELEKTRİK KABLOSU**3834 / 3832****Certificated**

- ✓ ISO 6722
- ✓ ISO 1724



Product Speciality Ürün Özelliği	Electric Braking System Cable	Elektrikli Fren Sistemleri için Elektrik Kablosu
Wire Cross-Section mm ² Kablo Kesitleri mm ²	6x1 + 1x1,5	6x1 + 1x1,5
Material Hammadde	PVC	PVC
Temperature Res. Sıcaklık Dayanıklılığı	-40 °C / +85 °C	-40 °C / +85 °C

Variants Değişenler	Order Number Sipariş Kodu	EN3834F	ES3834F	E3832F
	Voltage Compatability Voltaj Uyumluluğu	24 / 24V	24 / 24V	12 / 12V
	Max. Working Length Maks. Çalışma Boyu	3m	3m	3m
		25 pcs Adet	38x78x18 cm	

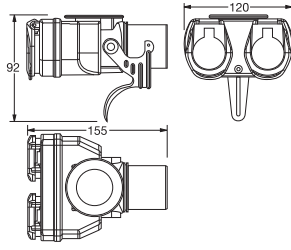
Adapter | Adaptör

 15 Pole 24V Socket ISO 12098 >
 2x7 Pole (N&S Type) ISO 1185 ISO 3731
 15 Pinli 24V Soket > 2x7 Pinli (N&S Tip)

 Order Number
 Sipariş Kodu

E4017

35 pcs Adet 38x78x18 cm

 ISO 7638
 ISO 12098
IP69K

 ABS Plug with Screw / Crimp Pins
 ABS Fiş Vidalı / Sıkmalı Pinli

 With Crimp Contact Pins
 Sıkmalı Pinli

 With Screw Contact Pins
 Vidalı Pinli

5 Pin ABS Plug | 5 Pinli ABS Fiş

E4005FQ1
E4005FQ1/FK

7 Pin ABS Plug | 7 Pinli ABS Fiş

E4007FQ1
E4007FQ1/FK

9 Pin ABS Plug | 9 Pinli ABS Fiş

E4009FQ1
E4009FQ1/FK

13 Pin ABS Plug | 13 Pinli ABS Fiş

E4013FQ1
E4013FQ1/FK

15 Pin ABS Plug | 15 Pinli ABS Fiş

E4015FQ1
E4015FQ1/FK

40 pcs Adet 41x41x41 cm

 ISO 7638
 ISO 12098
IP69K

 ABS Socket with Screw / Crimp Pins
 ABS Soket Vidalı / Sıkmalı Pinli

 With Crimp Contact Pins
 Sıkmalı Pinli

 With Screw Contact Pins
 Vidalı Pinli

5 Pin ABS Plug | 5 Pinli ABS Fiş

E4705FQ1
E4705FQ1/FK

7 Pin ABS Plug | 7 Pinli ABS Fiş

E4707FQ1
E4707FQ1/FK

9 Pin ABS Plug | 9 Pinli ABS Fiş

E4709FQ1
E4709FQ1/FK

13 Pin ABS Plug | 13 Pinli ABS Fiş

E4713FQ1
E4713FQ1/FK

15 Pin ABS Plug | 15 Pinli ABS Fiş

E4715FQ1
E4715FQ1/FK

40 pcs Adet 41x41x41 cm



ISO 12098

Park Socket
 Park Soket

 Order Number
 Sipariş Kodu

E2617

40 pcs Adet 38x78x18 cm

 ISO 3731 ISO 1185		Socket Soket		Plug Fiş		
		Screw Connection Vidalı	Terminal Connection Terminalli	Screw Connection Vidalı	Terminal Connection Terminalli	
 Socket Soket	 Plug Fiş	N Type 7 Pin 24V N Tipi 7 Pinli 24V	EN3817FK	EN3817FF	EN3815FK	EN3815FF
 Socket Soket	 Plug Fiş	S Type 7 Pin 24V S Tipi 7 Pinli 24V	ES3817FK	ES3817FF	ES3815FK	ES3815FF
 Socket Soket	 Plug Fiş	N Type 7 Pin 24V N Tipi 7 Pinli 24V	EN4817FK	EN4817FF	EN3816FK	EN3816FF
 Socket Soket	 Plug Fiş	S Type 7 Pin 24V S Tipi 7 Pinli 24V	ES4817FK	ES4817FF	ES3816FK	ES3816FF



	For Crimp Conn.	For Screw Conn.
1,5~2,5 mm ² Pins for Plug Fişler için 1,5~2,5 mm ² Pinler	QKVABS15 Length: 3,4 cm	QKV100S Length: 4,8 cm
4~6 mm ² Pins for Plug Fişler için 4~6 mm ² Pinler	QKVABS40 Length: 3,4 cm	QKV101S Length: 3,6 cm
1,5~2,5 mm ² Pins for Socket Soketler için 1,5~2,5 mm ² Pinler	QKP96 Length: 3,6 cm	QKP100K Length: 5,6 cm
4~6 mm ² Pins for Socket Soketler için 4~6 mm ² Pinler	QKP97 Length: 3,6 cm	QKP101K Length: 4,4 cm



Socket | Soket

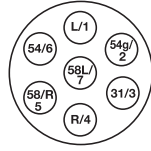

Plug | Fiş

7 Pole Socket&Plug 12V Aluminium Housing
7 Pinli Alüminyum Fiş&Soket 12V



ISO 1724

Order Number | Sipariş Kodu

Socket | Soket

Plug | Fiş

E2318FK

E2317FK



100 pcs Adet 27x50,5x27 cm



Socket | Soket

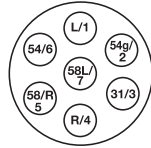

Plug | Fiş

7 Pole Socket&Plug 12V Aluminium Housing
7 Pinli Alüminyum Fiş&Soket 12V



ISO 1724

Order Number | Sipariş Kodu

Socket | Soket

Plug | Fiş

E3827FK

E3826FK



100 pcs Adet 27x50,5x27 cm



Plug for Heavy Duty Cable
Ağır Çalışma Kabloları için Fiş

Order Number | Sipariş Kodu

N Type | N Tip

S Type | S Tip

EN3818FK

ES3818FK

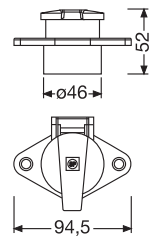
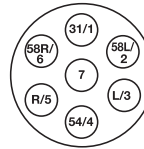

Special Socket for Easy Maintenance / 24V
Kolay Bakım için Tasarlanan Özel Soket / 24V

Order Number | Sipariş Kodu

N Type | N Tip

S Type | S Tip

EN4818FF

ES4818FF



Socket | Soket



Plug | Fiş

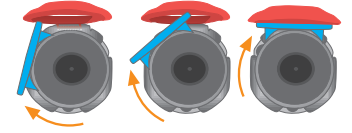

Easy Opening & Locking Operation By Rotating



ISO 11446

13Pin 12V Plug/Socket with Screw Terminals for 7-13 Core Cables
13 Pinli 12V Fiş/Soket Vidalı Terminalli 7-13 Damarlı Kablolar için

Socket Soket	Order Number Sipariş Kodu	Plug Fiş
E2313	100 pcs Adet 27x50,5x27 cm	E2310 7 Pole Pin E2314 13 Pole Pin

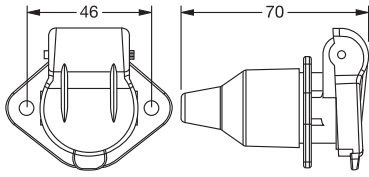

Socket | Soket

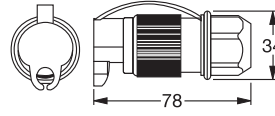

Plug | Fiş

3 Pin 6-24V Plug / Socket | 3 Pin 6-24V Fiş / Soket

DIN 9680

Socket Soket	Order Number Sipariş Kodu	Plug Fiş
E4704	200 pcs Adet 29x40x23 cm	E2320

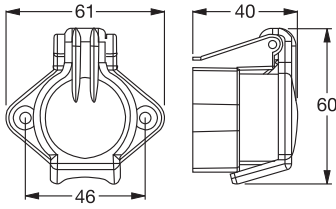

Socket | Soket

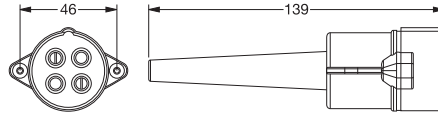

Plug | Fiş

4 Pin 6-24V Plug / Socket | 4 Pin 6-24V Fiş / Soket

DIN 72575

Socket Soket	Order Number Sipariş Kodu	Plug Fiş
E3830	200 pcs Adet 29x40x23 cm	E3828

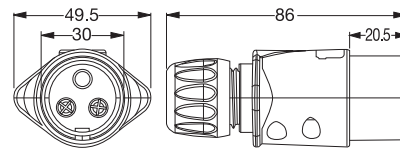
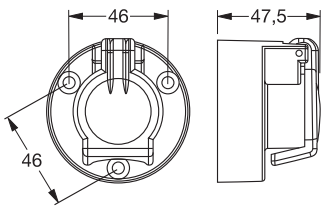

3 Pin 6-24V Plug / Socket | 3 Pin 6-24V Fiş / Soket

Socket Soket	Order Number Sipariş Kodu	Plug Fiş
E4703	200 pcs Adet 29x40x23 cm	E4706



Single Pole Power Plug (High Amper)
Tek Kutuplu Güç Fişi (Yüksek Amper için)

Order Number | Sipariş Kodu

0449F



Single Pole Power Plug
Tek Kutuplu Güç Fişi

Order Number | Sipariş Kodu

0447F



Single Pole Power Plug (With Cap)
Tek Kutuplu Güç Fişi (Kapaklı)

Order Number | Sipariş Kodu

0448F

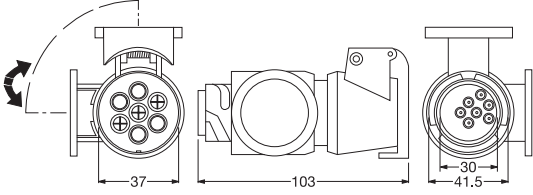

ISO 11446
ISO 1724

12V Short Adapter Socket 7 Poles
12V Kısa Adaptör Soket 7 Kutup

Order Number | Sipariş Kodu
Socket | Soket



DME2311

100 pcs Adet
29x40x23 cm

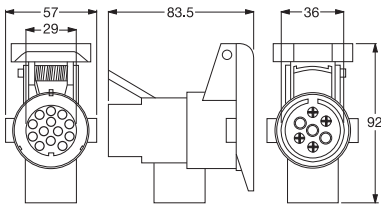

ISO 11446
ISO 1724

12V Short Adapter Socket 7-13 Poles
12V Kısa Adaptör Soket 7-13 Kutup

Order Number | Sipariş Kodu
Socket | Soket



DME2312

100 pcs Adet
29x40x23 cm

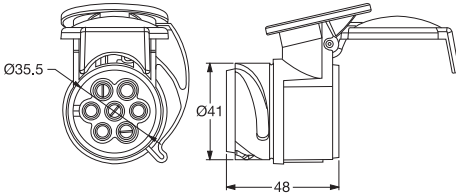

ISO 11446
ISO 1724

12V Short Adapter Socket 7 Poles
12V Kısa Adaptör Soket 7 Kutup

Order Number | Sipariş Kodu
Socket | Soket



DME2315

100 pcs Adet
29x40x23 cm

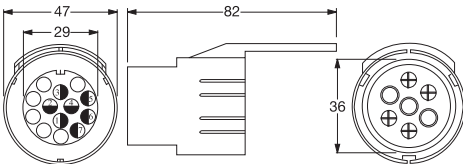

ISO 11446
ISO 1724

12V Short Adapter Socket 7 Poles
12V Kısa Adaptör Soket 7 Kutup

Order Number | Sipariş Kodu
Socket | Soket



DME2321

100 pcs Adet
29x40x23 cm

Heavy Duty Spiral Twin Cable 24V Ağır İş Spiral İkiz Kablo 24V



according to
VG 96917 ✓



	2 Plugs, 2 Pins with Plug		Without Plug	
Cable with Connectors Bağlantısız Yalnız Kablo	E4220F40	E4220F60	E4320F40	E4320F60
Voltage Compatability Voltaj Uyumluluğu	35	35	35	35
Turns / Internal Diameter Sarım Sayısı / İç Çap mm	52 / 40 mm	84 / 40 mm	52 / 40 mm	84 / 40 mm
Cable Lenght (m)/Working Length (m) Kablo Uzunluğu (m)/Çalışma Uzunluğu (m)	5,4 / 4	8,1 / 6	5,4 / 4	8,1 / 6
	5 pcs Adet 38X78X18 cm			

Heavy Duty Aluminium Socket with Silver Plated
Crimp Contact (x2) for Cables
Ağır İş Alüminyum Soket-Gümüş Kaplı
Kontak (x2) Kablolar için

Order Number Sipariş Kodu	Contact Section	
	35mm ²	50mm ²
E4702	E4710	
50 pcs Adet	38x78x18 cm	



according to
VG 96917 ✓



Heavy Duty Aluminium Plug with Silver Plated
Crimp Contact (x2) for Cables
Ağır İş Alüminyum Fiş-Gümüş Kaplı
Kontak (x2) Kablolar için

Order Number Sipariş Kodu	Contact Section	
	35mm ²	50mm ²
E4002	E4711	
50 pcs Adet	38x78x18 cm	



according to
VG 96917 ✓



Heavy Duty Aluminium Plug with Silver Plated
Crimp Contact (x2) for Cables
Ağır İş Alüminyum Fiş-Gümüş Kaplı
Kontak (x2) Kablolar için

Order Number Sipariş Kodu	Contact Section	
	35mm ²	50mm ²
E2328	E2329	
100 pcs Adet	51x27x27 cm	



according to
VG 96917 ✓



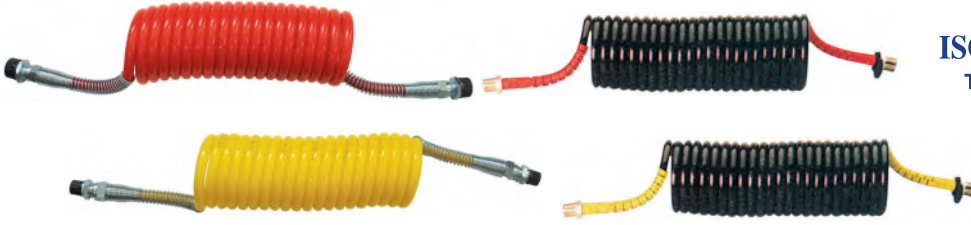

according to
ISO7375 ✓ **ISO7628** ✓
TEST REPORT AVAILABLE

Hose thickness
Hortum Kalınlığı

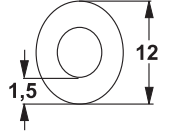

POLYAMIDE 12 POLİEMİT 12 DIN 74324	Turns	Colors	Anti Kint Protection	Thread	Inner Ø 70 mm	Inner Ø 90 mm
	Spir	Renk	Kol Koruması	Rakor	İç Çap 70 mm	İç Çap 90 mm
	19	● ●	Plastic Plastik	M16	F3820H19S16	F3820HV19S16
	19	● ●	Plastic Plastik	M16	F3820H19K16	F3820HV19K16
	19	● ●	Plastic Plastik	M22	F3820H19S22	F3820HV19S22
	19	● ●	Plastic Plastik	M22	F3820H19K22	F3820HV19K22
	22	● ●	Plastic Plastik	M16	F3820H22K16	F3820HV22K16
	22	● ●	Plastic Plastik	M16	F3820H22S16	F3820HV22S16
	22	● ●	Plastic Plastik	M22	F3820H22S22	F3820HV22S22
	22	● ●	Plastic Plastik	M22	F3820H22K22	F3820HV22K22
	30	● ●	Plastic Plastik	M16	F3820H30S16	F3820HV30S16
	30	● ●	Plastic Plastik	M16	F3820H30K16	F3820HV30K16
	30	● ●	Plastic Plastik	M22	F3820H30S22	F3820HV30S22
	30	● ●	Plastic Plastik	M22	F3820H30K22	F3820HV30K22
	19	● ●	Plastic Plastik	M16	F3820H19Z16	F3820HV19Z16
	22	● ●	Plastic Plastik	M16	F3820H22Z16	F3820HV22Z16
	30	● ●	Plastic Plastik	M16	F3820H30Z16	F3820HV30Z16
19	● ●	Plastic Plastik	M22	F3820H19Z22	F3820HV19Z22	
22	● ●	Plastic Plastik	M22	F3820H22Z22	F3820HV22Z22	
30	● ●	Plastic Plastik	M22	F3820H30Z22	F3820HV30Z22	

Hose thickness
Hortum Kalınlığı

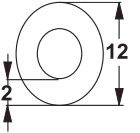

POLYETHYLENE POLİETİLEN	Turns	Colors	Anti Kint Protection	Thread	Inner Ø 70 mm	Inner Ø 90 mm
	Spir	Renk	Kol Koruması	Rakor	İç Çap 70 mm	İç Çap 90 mm
	19	●	Spring Yay	M16	F3819HW19S16	F3819HVW19S16
	19	●	Spring Yay	M22	F3819HW19K22	F3819HVW19K22
	22	●	Spring Yay	M16	F3819HW22S16	F3819HVW22S16-7,5 MT
	22	●	Spring Yay	M22	F3819HW22K22	F3819HVW22K22-7,5 MT
	25	●	Spring Yay	M16	F3819HW25S16	F3819HVW25S16
	25	●	Spring Yay	M22	F3819HW25K22	F3819HVW25K22
	30	●	Spring Yay	M22	F3819HW30S22	F3819HVW30S22
	30	●	Spring Yay	M16	F3819HW30K16	F3819HVW30K16
	22	●	Spring Yay	M22	F3819HW22M22	F3819HVW22M22-7,5 MT
	19	● ●	Plastic Plastik	M16	F3819HK19Z16	F3819HVK19Z16
	22	● ●	Plastic Plastik	M22	F3819HS22Z22	F3819HVS22Z22-7,5 MT
	19	● ●	Spring Yay	M16	F3819HW19K16	F3819HVW19K16
	19	● ●	Spring Yay	M22	F3819HW19S22	F3819HVW19S22
	22	● ●	Spring Yay	M16	F3819HW22K16	F3819HVW22K16-7,5 MT
	22	● ●	Spring Yay	M22	F3819HW22S22	F3819HVW22S22-7,5 MT
30	● ●	Spring Yay	M16	F3819HW30S16	F3819HVW30S16	
30	● ●	Spring Yay	M22	F3819HW30K22	F3819HVW30K22	
25	● ●	Spring Yay	M16	F3819HW25K16	F3819HVW25K16	
25	● ●	Spring Yay	M22	F3819HW25S22	F3819HVW25S22	

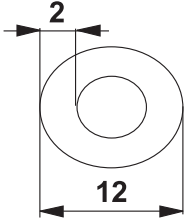

Inner Ø 70 mm
İç Çap 70 mm

Hose thickness
Hortum Kalınlığı



POLYURETHANE (TPU) POLİÜRETAN (TPU)	Turns	Colors	Tip guard	Thread	Metal Conn.	Brass Conn.
	Spir	Renk	Uç Koruması	Rakor	Metal Konnektör	Pirinç Konnektör
	19	●	Spring Yay	M22	F3128HKW22MT	F3128HKW22PR
	19	●	Spring Yay	M16	F3128HKW16MT	F3128HKW16PR
	19	●	Spring Yay	M22	F3128HSW22MT	F3128HSW22PR
	19	●	Spring Yay	M16	F3128HSW16MT	F3128HSW16PR
	22	●	Red Plastic Kırmızı Plastik	M22	F3128HZK22MT	F3128HZK22PR
	22	●	Red Plastic Kırmızı Plastik	M16	F3128HZK16MT	F3128HZK16PR
	22	●	Yellow Plastic Sarı Plastik	M22	F3128HZZ16MT	F3128HZZ16PR
	22	●	Yellow Plastic Sarı Plastik	M16	F3128HZZ16MT	F3128HZZ16PR
	30	●	Blue Plastic Mavi Plastik	M22	F3128HZZ22MT	F3128HZZ22PR
	30	●	Blue Plastic Mavi Plastik	M16	F3128HZZ16MT	F3128HZZ16PR
30	●	Spring Yay	M16	F3128HZZ16MT	F3128HZZ16PR	

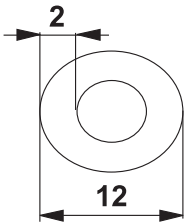

Big Hose Inner Diameter 70 mm
Büyük Hortum İç Çapı 70 mm

Small Hose Inner Diameter 55 mm
Küçük Hortum İç Çapı 55 mm

Hose thickness
Hortum Kalınlığı



POLYURETHANE (TPU) POLİÜRETAN (TPU)	Turns	Colors	Tip guard	Thread	Metal Conn.	Brass Conn.
	22	● / ●	Spring Yay	M22	F3129HSKW22MT	F3129HSKW22PR
	22	● / ●	Spring Yay	M16	F3129HSKW16MT	F3129HSKW16PR
	22	● / ●	Spring Yay	M22	F3129HZZ22MT	F3129HZZ22PR
	22	● / ●	Spring Yay	M16	F3129HZZ16MT	F3129HZZ16PR
	22	● / ●	Red/Yellow Plastic Kırmızı/Sarı Plastik	M22	F3129HSKSK22MT	F3129HSKSK22PR
	22	● / ●	Red/Yellow Plastic Kırmızı/Sarı Plastik	M16	F3129HSKSK16MT	F3129HSKSK16PR
	22	● / ●	Black/Yellow Plastic Siyah/Sarı Plastik	M22	F3129HZZSZS22MT	F3129HZZSZS22PR
	22	● / ●	Black/Yellow Plastic Siyah/Sarı Plastik	M16	F3129HZZSZS16MT	F3129HZZSZS16PR



Palm-Couplings for Two Line System with Integrated Filter
Withworth 1/2 inches also available

M 16 x 1,5

For emergency Red **F3825KK16**

For brake Yellow **F3825KS16**



Palm-Couplings for Two Line System Confusion Preventing Type Automatic Type (with valve)
Withworth 1/2 inches also available

M 16 x 1,5 M 22 x 1,5

For emergency Red **F3822KK16 F3822KK22**

For brake Yellow **F3822KS16 F3822KS22**



Palm-Couplings for Two Line System Confusion Preventing Type Standart Type (w/o valve)

M 16 x 1,5 M 22 x 1,5

For emergency Red **F3823KK16 F3823KK22**

For brake Yellow **F3823KS16 F3823KS22**



Coupling Head Handle Kit

M 16 x 1,5

M 22 x 1,5

E2938M16

E2938M22



Aluminium Coupling Head Handle (One piece)

M 16 x 1,5

M 22 x 1,5

E2939M16

E2939M22



Drain Valve

M 16 x 1,5

M 22 x 1,5

F3824H16

F3824H22



Plastic Gun
Order No: **F2935-Z**
Different Colours also available



Metal Gun
Order No: **F2933H**

*Inner diameter 45mm

Turns	Colors	Working Length	Metal/Plastic Gun	CONNECTION TYPE			
				Without Gun	With Gun	Without Gun	With Gun
48	White	7,5m	Metal	F2930HB	F2931HB	F2936HB	F2937HB
48	Red	7,5m	Metal	F2930HK	F2931HK	F2936HK	F2937HK
48	Red	7,5m	Plastic	F2930HK	F2931HKP	F2936HK	F2937HKP
48	Blue	7,5m	Metal	F2930HM	F2931HM	F2936HM	F2937HM
48	Blue	7,5m	Plastic	F2930HM	F2931HMP	F2936HM	F2937HMP
48	Yellow	7,5m	Metal	F2930HS	F2931HS	F2936HS	F2937HS
48	Yellow	7,5m	Plastic	F2930HS	F2931HSP	F2936HS	F2937HSP
48	Orange	7,5m	Metal	F2930HT	F2931HT	F2936HT	F2937HT
48	Green	7,5m	Metal	F2930HY	F2931HY	F2936HY	F2937HY
35	Red	5,5m	Metal	F2930HK55	F2932HK	F2936HK55	F2938HK
35	Blue	5,5m	Plastic	F2930HM55	F2932HMP	F2936HM55	F2938HMP
35	Yellow	5,5m	Metal	F2930HS55	F2932HS	F2936HS55	F2938HS
35	Red	5,5m	Plastic	F2930HK55	F2932HKP	F2936HK55	F2938HKP

Considering your demands, different connection, turns, dimensions and colours could be produced.

MRC Bus Tail Indicator Lamp (12 LEDs)
MRC Otobüs Arka Sinyal Lambası (12 Ledli)

Order Number | Sipariş Kodu Connector Set

0391LUS-K

QSK55-STŞ

12/24V

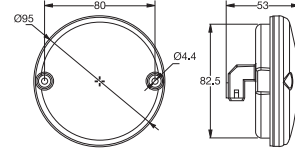

32 pcs Adet
29x40x23 cm
~4 kg



E9 LED EMC ECE R10 IP69K

MRC Bus Tail Stop-Position Lamp (12 LEDs)
MRC Otobüs Arka Stop ve Pozisyon Lambası (12 Ledli)

Order Number | Sipariş Kodu Connector Set

0392LUK-K

QSK56-STŞ

12/24V

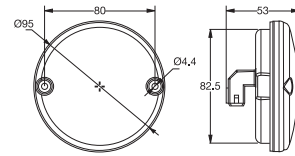

32 pcs Adet
29x40x23 cm
~4 kg



E9 LED EMC ECE R10 IP69K

MRC Bus Reverse Lamp (12 LEDs)
MRC Otobüs Geri Vites Lambası (12 Ledli)

Order Number | Sipariş Kodu Connector Set

0394LUB-K

QSK55-STŞ

12/24V

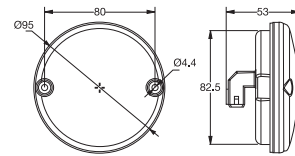

32 pcs Adet
29x40x23 cm
~4 kg



E9 LED EMC ECE R10 IP69K

MRC Bus Tail Fog Lamp (12 LEDs)
MRC Otobüs Arka Sis Lambası (12 Ledli)

Order Number | Sipariş Kodu Connector Set

0395LUK-K

QSK55-STŞ

12/24V

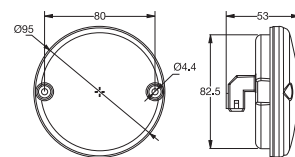

32 pcs Adet
29x40x23 cm
~4 kg



E9 LED EMC ECE R10 IP69K

MRC Bus Tail Fog Lamp (12 LEDs)
MRC Otobüs Arka Sis Lambası (12 Ledli)

Order Number | Sipariş Kodu Connector Set

0396LUK-1

QSK55-STŞ

12/24V

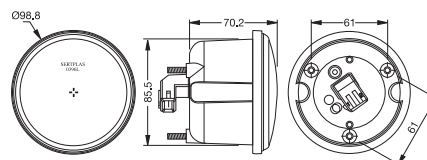

56 pcs Adet
43x71x22 cm
~10,5 kg



E9 LED EMC ECE R10 IP69K

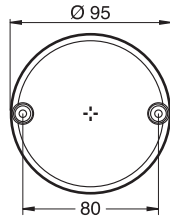

12/24V

MRC Bus Tail Indicator Lamp with Cable (12 LEDs)
MRC Kablolu Otobüs Arka Sinyal Lambası (12 Ledli)

Order Number Sipariş Kodu		
With Cable Kablolu	Assembly Base Montaj Plastikli	Connector Base Bağlantı Plastikli
0391LUS25	0391LUS25-M	0391LUS25-B
	32 pcs Adet	29x40x23 cm ~4 kg

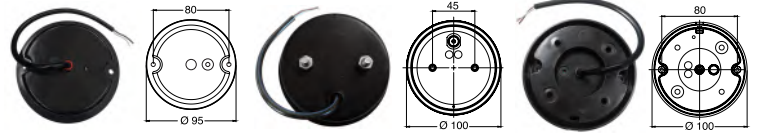

Cable Length
Kablo Uzunluğu
25 cm

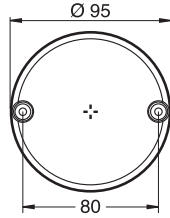

12/24V

MRC Bus Tail Stop-Position Lamp with Cable (12 LEDs)
MRC Kablolu Otobüs Stop ve Pozisyon Lambası (12 Ledli)

Order Number Sipariş Kodu		
With Cable Kablolu	Assembly Base Montaj Plastikli	Connector Base Bağlantı Plastikli
0392LUK25	0392LUK25-M	0392LUK25-B
	32 pcs Adet	29x40x23 cm ~4 kg

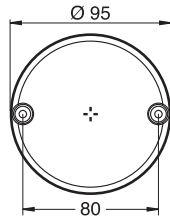

12/24V

MRC Bus Reverse Lamp with Cable (12 LEDs)
MRC Kablolu Otobüs Geri Vites Lambası (12 Ledli)

Order Number Sipariş Kodu		
With Cable Kablolu	Assembly Base Montaj Plastikli	Connector Base Bağlantı Plastikli
0394LUB25	0394LUB25-M	0394LUB25-B
	32 pcs Adet	29x40x23 cm ~4 kg

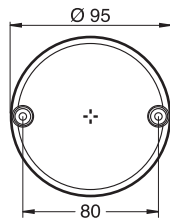
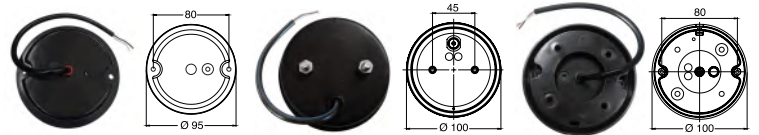

12/24V

MRC Bus Fog Lamp with Cable (12 LEDs)
MRC Kablolu Otobüs Arka Sis Lambası (12 Ledli)

Order Number Sipariş Kodu		
With Cable Kablolu	Assembly Base Montaj Plastikli	Connector Base Bağlantı Plastikli
0395LUK25	0395LUK25-M	0395LUK25-B
	32 pcs Adet	29x40x23 cm ~4 kg

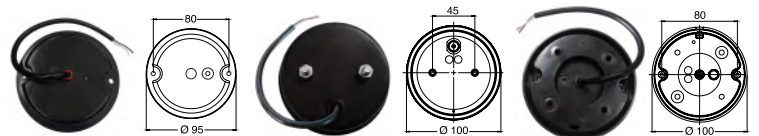

Indicator Lamp with Cable (8 LEDs) Kablolu Sinyal Lambası (8 Ledli)

The Lamp without Plug is available

Order Number
Sipariş Kodu

0089LUS

25 pcs Adet
37x19x15 cm
~2,5 kg

Cable Length
Kablo Uzunluğu
15 cm



12/24V

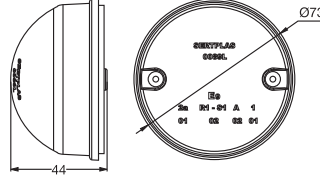

Stop / Position Lamp with Cable (8 LEDs) Kablolu Stop / Pozisyon Lambası (8 Ledli)

The Lamp without Plug is available

Order Number
Sipariş Kodu

0089LUK

25 pcs Adet
37x19x15 cm
~2,5 kg

Cable Length
Kablo Uzunluğu
15 cm



12/24V

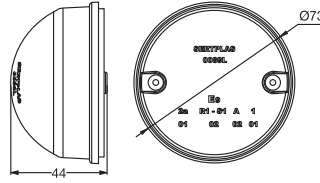

Front Position Lamp with Cable (8 LEDs) Kablolu Ön Pozisyon Lambası (8 Ledli)

The Lamp without Plug is available

Order Number
Sipariş Kodu

0089LUB

25 pcs Adet
37x19x15 cm
~2,5 kg

Cable Length
Kablo Uzunluğu
15 cm



12/24V

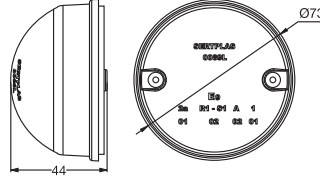

Front Direction Indicator Lamp with Cable (8 LEDs) Kablolu Ön Sinyal Lambası (8 Ledli)

The Lamp without Plug is available

Order Number
Sipariş Kodu

0089LUSB

25 pcs Adet
37x19x15 cm
~2,5 kg

Cable Length
Kablo Uzunluğu
15 cm



12/24V

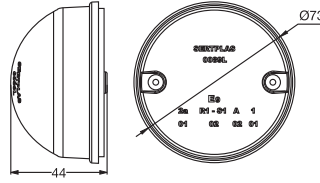



24V

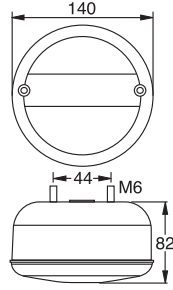

Hamburger Type Rear Lamp with LED
Hamburger Tip LEDli Arka Lamba

Order Number | Sipariş Kodu

0230LLED

24 pcs Adet
42,5x43x30 cm
~12,2 kg



24V

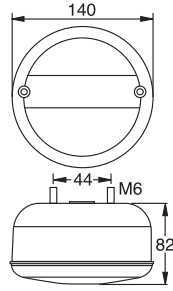

Hamburger Type Fog & Reverse Lamp with LED
Hamburger Tip LEDli Sis&Geri Vites Lambası

Order Number | Sipariş Kodu

0375LLED

24 pcs Adet
42,5x43x30 cm
~12 kg



24V

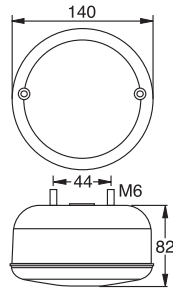

Hamburger Type Fog Lamp with LED
Hamburger Tip LEDli Sis Lambası

Order Number | Sipariş Kodu

0361LLED

24 pcs Adet
42,5x43x30 cm
~11,3 kg



24V

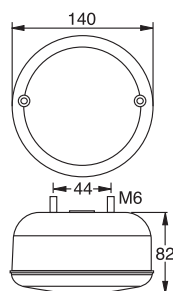

Hamburger Type Reverse Lamp with LED
Hamburger Tip LEDli Geri Vites Lambası

Order Number | Sipariş Kodu

0363LLED

24 pcs Adet
42,5x43x30 cm
~11,4 kg



24V

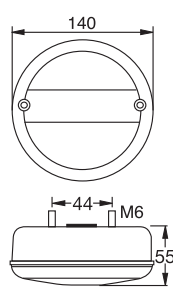

Hamburger Type Rear Lamp with LED
Hamburger Tip LEDli Arka Lambası

Order Number | Sipariş Kodu

0380L

24 pcs Adet
42,5x43x30 cm
~10,4 kg

Multifunction Tail Lamp

0366

LED'li Çok Fonksiyonlu Kuyruk Lambası

Functions Stop, Side Marker, Position, Reflector, Rear Fog, Indicator, Front Position, Reverse, Num. Plate

Fonksiyonlar Stop, Yan Marker, Pozisyon, Reflektör, Arka Sis, Sinyal, Ön Pozisyon, Geri Vites, Plaka Lambası

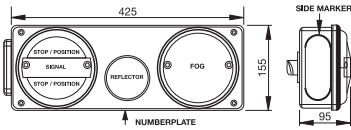

Without LED Marker
LED Boynuzsuz

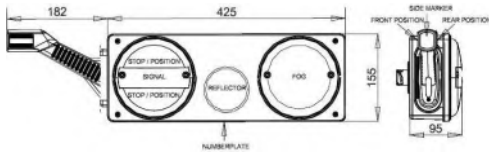

With LED Marker
LED Boynuzlu

A Light Control Gear kit is integrated to product against to Indicator Failures. This Light Control Gear (LCG) enables truck&trailers with a non LED conform electrical system to operate LED lamps by adjust the electrical properties.

Order Number | Sipariş Kodu



Left
Sol



Right
Sağ



Left
Sol



Right
Sağ

0366LL73Q2

0366LR73Q2

0366LL73Q25

0366LR73Q25



15 pcs Adet
80x40x46 cm
~17,7 kg



12 pcs Adet
51x60,5x46,5 cm
~25 kg

Fastening Bolts | Bağlantı Civataları

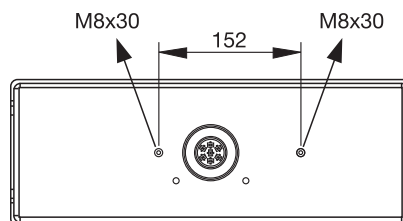

0302

Multifunction Tail Lamp

Çok Fonksiyonlu Kuyruk Lambası

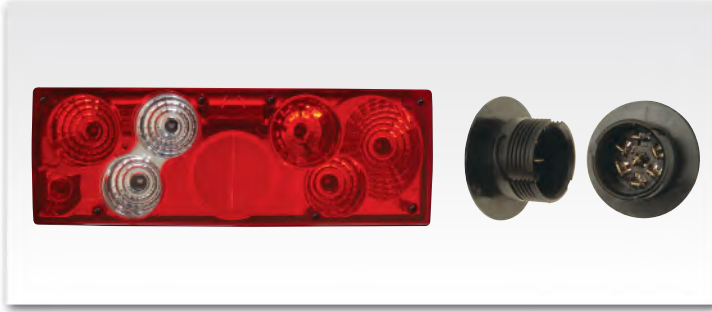

Functions	Reverse, End Outline Marker, Stop, Side Marker, Position, Reflector, Rear Fog, Indicator, Num. Plate
Fonksiyonlar	Geri Vites, Uç Yan Marker, Stop, Yan Marker, Pozisyon, Reflektör, Sinyal, Arka Sis, Plaka

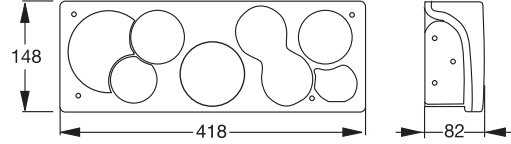

Order Number | Sipariş Kodu



Left
Sol

Right
Sağ

0302LL73Q2

0302LR73Q2



13 pcs Adet
40x59x43 cm
~17,9 kg

Only Lens | Sadece Cam



0302CL

0351CR



50 pcs Adet
49,5x58x58 cm
~20,9 kg

Fastening Bolts | Bağlantı Civataları

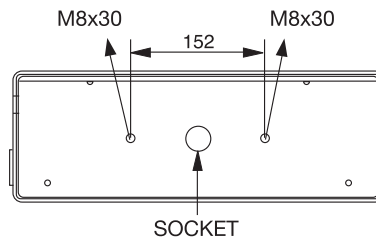

Multifunction Tail Lamp

0360

Çok Fonksiyonlu Kuyruk Lambası

Functions Reverse, End Outline Marker, Stop, Side Marker, Position, Reflector, Rear Fog, Indicator, Num. Plate

Fonksiyonlar Geri Vites, Uç Yan Marker, Stop, Yan Marker, Pozisyon, Reflektör, Sinyal, Arka Sis, Plaka

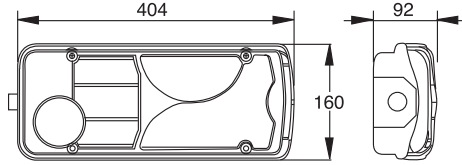

Order Number | Sipariş Kodu



Left
Sol

0360LLBB742



Right
Sağ

0360LRBB742



Left
Sol

0360LLMM742



Right
Sağ

0360LRMM742



20 pcs Adet
49,5x58x58 cm
~23,9 kg

Only Lens | Sadece Cam



0360CLBB



0360CRBB



0360CLMM



0360CRMM



18 pcs Adet
33x75x41,5 cm
~8,8 kg

Fastening Bolts | Bağlantı Civataları

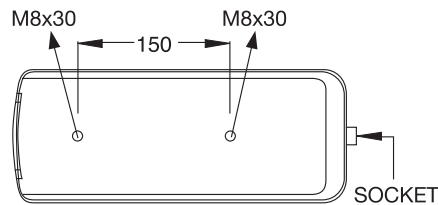

0030

Multifunction Tail Lamp

Çok Fonksiyonlu Kuyruk Lambası



Functions Reverse, End-Outline Marker, Stop, Side Marker, Position, Reflector, Rear Fog, Indicator, Num. Plate

Fonksiyonlar Geri Vites, Uç Yan Marker, Stop, Yan Marker, Pozisyon, Reflektör, Sinyal, Arka Sis, Plaka

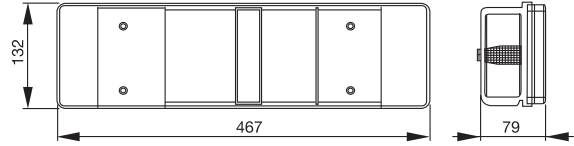

Order Number | Sipariş Kodu



Left Sol	Socket Type Bağlantı Tipi	Right Sağ	
0030LL744 SE Type AMP		0030LR744	14 pcs Adet 29x82,5x49,5 cm ~17,6 kg
0030LL741 US Type AMP		0030LR741	14 pcs Adet 29x82,5x49,5 cm ~17,2 kg
0030LL742 SE Type AMP		0030LR742	14 pcs Adet 29x82,5x49,5 cm ~17,8 kg
0030LL501 US Universal Socket		0030LR501	14 pcs Adet 29x82,5x49,5 cm ~16,9 kg
0030LL511 US Universal Socket and Cable (60 cm)		0030LR511	14 pcs Adet 29x82,5x49,5 cm ~18,4 kg

Only Lens | Sadece Cam



0030CU



30 pcs Adet
28x41x51 cm
~10,5 kg

Fastening Bolts | Bağlantı Civataları

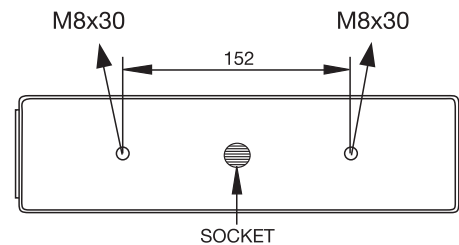

Multifunction Tail Lamp

0030

Çok Fonksiyonlu Kuyruk Lambası



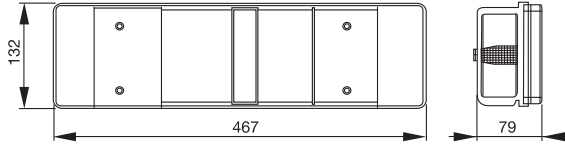

Functions Reverse, End-Outline Marker, Stop, Side Marker, Position, Reflector, Rear Fog, Indicator, Num. Plate

Fonksiyonlar Geri Vites, Uç Yan Marker, Stop, Yan Marker, Pozisyon, Reflektör, Sinyal, Arka Sis, Plaka

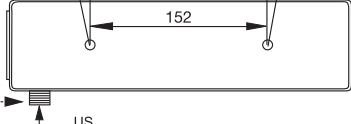

Order Number | Sipariş Kodu

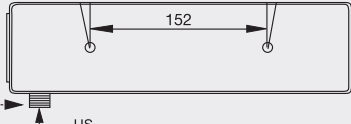

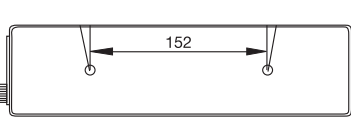
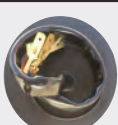
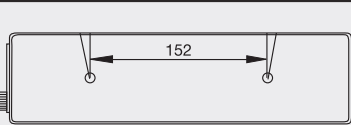
Left Sol	Socket Type Bağlantı Tipi	Right Sağ	
0030LL601 US Gromet Type	 	0030LR601	14 pcs Adet 29x82,5x49,5 cm ~16,9 kg
0030LL611 US Gromet and Cable (30 cm)	 	0030LR611	14 pcs Adet 29x82,5x49,5 cm ~17,9 kg
0030LL602 SE Gromet Type	 	0030LR602	14 pcs Adet 29x82,5x49,5 cm ~16,9 kg
0030LL612 SE Gromet and Cable (30 cm)	 	0030LR612	14 pcs Adet 29x82,5x49,5 cm ~18 kg

Only Lens | Sadece Cam



0030CU



30 pcs Adet
28x41x51 cm
~10,5 kg

Fastening Bolts | Bağlantı Civataları

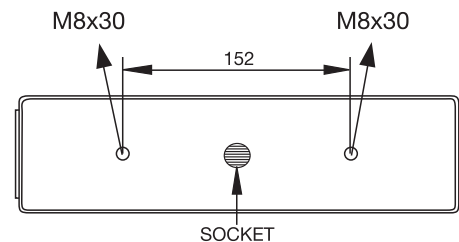

0030

Multifunction Tail Lamp

Çok Fonksiyonlu Kuyruk Lambası



Functions Reverse, End-Outline Marker, Stop, Side Marker, Position, Reflector, Rear Fog, Indicator, Num. Plate

Fonksiyonlar Geri Vites, Uç Yan Marker, Stop, Yan Marker, Pozisyon, Reflektör, Sinyal, Arka Sis, Plaka

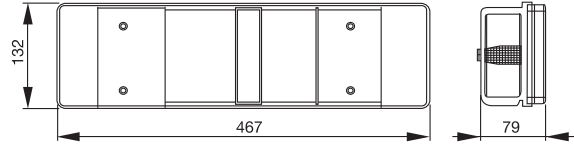

Order Number | Sipariş Kodu



Left Sol	Socket Type Bağlantı Tipi	Right Sağ	
0030LL71	Iveco Socket Type	0030LR71	14 pcs Adet 29x82,5x49,5 cm ~18 kg
0030LL72	Schlemmer Socket Type	0030LR72	14 pcs Adet 29x82,5x49,5 cm ~17,7 kg
0030LL73	Austrian Blade Socket Type	0030LR73	14 pcs Adet 29x82,5x49,5 cm ~17,9 kg
0030LL74	AMP Socket Type	0030LR74	14 pcs Adet 29x82,5x49,5 cm ~17,6 kg
0030LL75	DAF Socket Type	0030LR75	14 pcs Adet 29x82,5x49,5 cm ~17,9 kg

Only Lens | Sadece Cam



0030CU



30 pcs Adet
28x41x51 cm
~10,5 kg

Fastening Bolts | Bağlantı Civataları

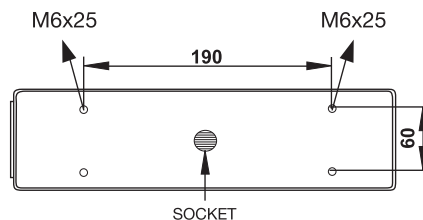

For 0030LL71
(Iveco Type)

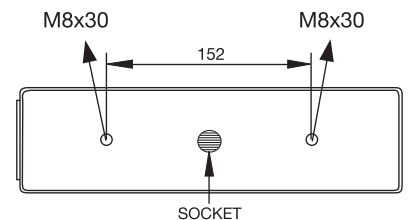

Multifunction Tail Lamp

0030

Çok Fonksiyonlu Kuyruk Lambası

Functions Reverse, End-Outline Marker, Stop, Side Marker, Position, Reflector, Rear Fog, Indicator, Num. Plate

Fonksiyonlar Geri Vites, Uç Yan Marker, Stop, Yan Marker, Pozisyon, Reflektör, Sinyal, Arka Sis, Plaka

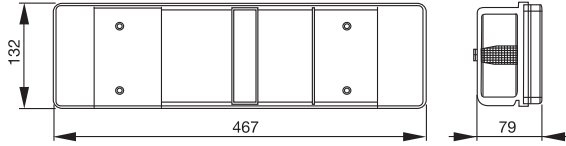

Order Number | Sipariş Kodu



Left Sol	Socket Type Bağlantı Tipi	Right Sağ	
0030LL50 Universal Gromet		0030LR50	14 pcs Adet 29x82,5x49,5 cm ~17,8 kg
0030LL51 Universal Socket with Cable (60 cm)		0030LR51	14 pcs Adet 29x82,5x49,5 cm ~18,2 kg
0030LL60 With Gromet Socket		0030LR60	14 pcs Adet 29x82,5x49,5 cm ~16,9 kg
0030LL61 With Gromet Socket and Cable (30 cm)		0030LR61	14 pcs Adet 29x82,5x49,5 cm ~17,9 kg

Only Lens | Sadece Cam



0030CU



30 pcs Adet
28x41x51 cm
~10,5 kg

Fastening Bolts | Bağlantı Civataları

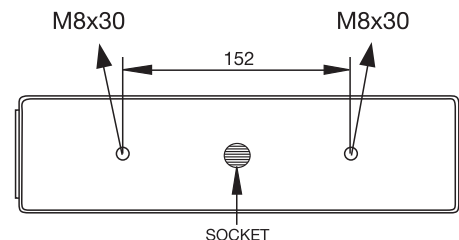

0031

Multifunction Tail Lamp

Çok Fonksiyonlu Kuyruk Lambası



Functions Reverse, End-Outline Marker, Stop, Side Marker, Position, Reflector, Rear Fog, Indicator, Num. Plate

Fonksiyonlar Geri Vites, Uç Yan Marker, Stop, Yan Marker, Pozisyon, Reflektör, Sinyal, Arka Sis, Plaka

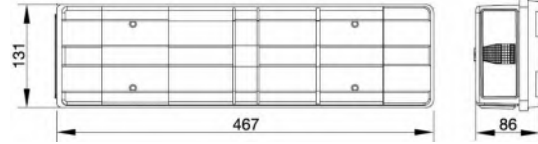

Order Number | Sipariş Kodu



Left Sol	Socket Type Bağlantı Tipi	Right Sağ	
0031LL74 BC Type AMP		0031LR74	14 pcs Adet 29x82,5x49,5 cm ~18,2 kg
0031LL741 US Type AMP		0031LR741	14 pcs Adet 29x82,5x49,5 cm ~16,6 kg
0031LL742 SE Type AMP		0031LR742	14 pcs Adet 29x82,5x49,5 cm ~18,4 kg
0031LL72 Schlemmer Socket		0031LR72	14 pcs Adet 29x82,5x49,5 cm ~18,4 kg

Only Lens | Sadece Cam



0031CU



20 pcs Adet
28x35x51 cm
~8,5 kg

Fastening Bolts | Bağlantı Civataları

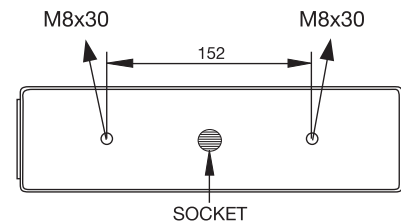

Multifunction Tail Lamp

0031

Çok Fonksiyonlu Kuyruk Lambası

Functions Reverse, End-Outline Marker, Stop, Side Marker, Position, Reflector, Rear Fog, Indicator, Num. Plate

Fonksiyonlar Geri Vites, Uç Yan Marker, Stop, Yan Marker, Pozisyon, Reflektör, Sinyal, Arka Sis, Plaka

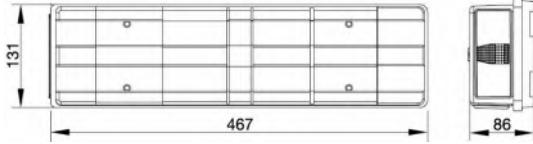

Order Number | Sipariş Kodu



Left Sol	Socket Type Bağlantı Tipi	Right Sağ	
0031LL50 Universal Gromet		0031LR50	14 pcs Adet 29x82,5x49,5 cm ~17,9 kg
0031LL51 Universal Gromet with Cable (60 cm)		0031LR51	14 pcs Adet 29x82,5x49,5 cm ~19,5 kg
0031LL60 With Gromet		0031LR60	14 pcs Adet 29x82,5x49,5 cm ~18,1 kg
0031LL61 With Gromet and Cable (30 cm)		0031LR61	14 pcs Adet 29x82,5x49,5 cm ~18,6 kg
0031LL73 Austrian Blade Socket		0031LR73	14 pcs Adet 29x82,5x49,5 cm ~18,7 kg

Only Lens | Sadece Cam

**0031CU**

20 pcs Adet
28x35x51 cm
~8,5 kg

Fastening Bolts | Bağlantı Civataları

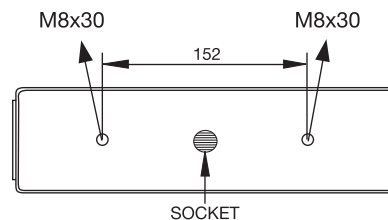

0284

Multifunction Tail Lamp

Çok Fonksiyonlu Kuyruk Lambası



Functions Stop, Side Marker, Position, Rear Fog, Indicator, Reverse

Fonksiyonlar Stop, Yan Marker, Pozisyon, Arka Sis, Sinyal, Geri Vites

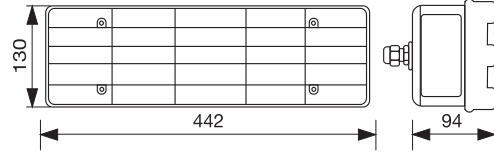

Order Number | Sipariş Kodu

Socket Type
Bağlantı Tipi



0284LU51 Universal Gromet with Cable (60 cm)



14 pcs Adet
41x80x47 cm
~20,3 kg

0284LU60 With Gromet

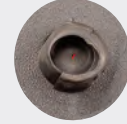

14 pcs Adet
41x80x47 cm
~19,4 kg

0284LU61 With Gromet & Cable (30 cm)



14 pcs Adet
41x80x47 cm
~20,4 kg

0284LU78 Iveco Socket Type



14 pcs Adet
41x80x47 cm
~14,4 kg

0284LU79 With Socket and Cable (190 cm)

14 pcs Adet
41x80x47 cm
~23,2 kg

Only Lens | Sadece Cam



0284CU



30 pcs Adet
28x55x49 cm
~11,6 kg

Fastening Bolts | Bağlantı Civataları

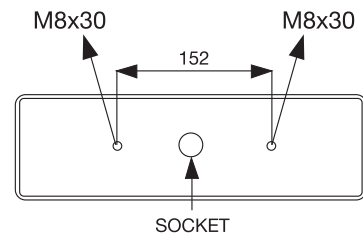

Multifunction Tail Lamp

0195

Çok Fonksiyonlu Kuyruk Lambası

Functions Stop, Position, Indicator, Reverse, Rear Fog, Reflector**Fonksiyonlar** Stop, Pozisyon, Sinyal, Geri Vites, Arka Sis, Reflektör

Order Number | Sipariş Kodu

Left
Sol

0195LLSK60

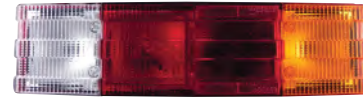
Right
Sağ

0195LRSB60

15 pcs Adet
27x60x43,5 cm
~13,5 kg

Only Lens | Sadece Cam



0195CUSK



0195CUSB

30 pcs Adet
36x41x47 cm
~9,9 kg

Fastening Bolts | Bağlantı Civataları

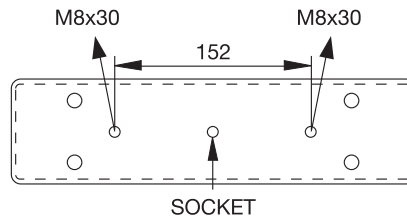

0205

Multifunction Tail Lamp

Çok Fonksiyonlu Kuyruk Lambası



Functions Reverse, Stop, Position, Reflector, Indicator, Rear Fog, Num. Plate

Fonksiyonlar Geri Vites, Stop, Pozisyon, Reflektör, Sinyal, Arka Sis, Plaka

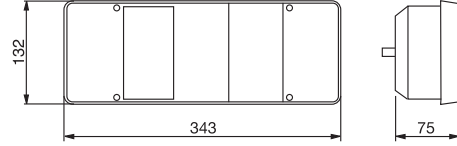

Order Number | Sipariş Kodu



Left Sol	Socket Type Bağlantı Tipi	Right Sağ	
0205LL51	Universal Gromet and Cable (60 cm)		0205LR51 18 pcs Adet 43x57x35 cm ~15 kg
0205LL60	With Gromet		0205LR60 18 pcs Adet 43x57x35 cm ~14,1 kg
0205LL72	Schlemmer Socket Type		0205LR72 18 pcs Adet 43x57x35 cm ~11,9 kg
0205LL74	AMP Socket Type		0205LR74 18 pcs Adet 43x57x35 cm ~14 kg

Only Lens | Sadece Cam



0205CU



30 pcs Adet
26x43x38 cm
~7,7 kg

Fastening Bolts | Bağlantı Civataları

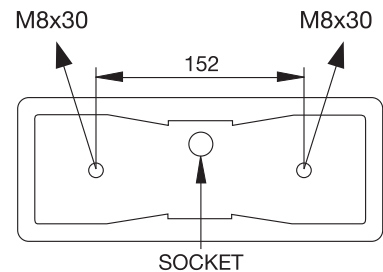

Multifunction Tail Lamp

Çok Fonksiyonlu Kuyruk Lambası

0294

Functions Stop, Position, Indicator, Reverse, Rear Fog, Reflector**Fonksiyonlar** Stop, Pozisyon, Sinyal, Geri Vites, Arka Sis, Reflektör

0294LLSB74 - 0294LLBB74

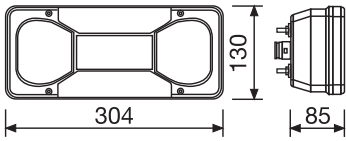

Fastening Bolts | Bağlantı Civataları

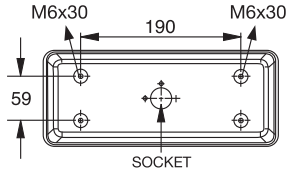

Order Number | Sipariş Kodu

Left
Sol

0294LL74SB

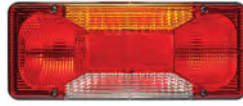
Right
Sağ

0294LR74SB

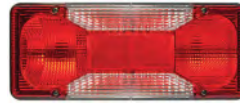
Left
Sol

0294LL74BB

Right
Sağ

0294LR74BB

20 pcs Adet
41,5x56,5x42,5 cm
~16,8 kg20 pcs Adet
41,5x56,5x42,5 cm
~16,8 kg

Only Lens | Sadece Cam



0294CLSB



0294CRSB



0294CUB

40 pcs Adet
28,5x54x34,5 cm
~9,8 kg40 pcs Adet
28,5x54x34,5 cm
~9,8 kg

0153

Multifunction Tail Lamp

Çok Fonksiyonlu Kuyruk Lambası



Functions Reverse, Stop, Position, Reflector, Indicator

Fonksiyonlar Geri Vites, Stop, Pozisyon, Reflektör, Sinyal

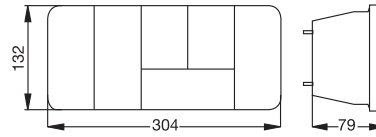

Fastening Bolts | Bağlantı Civataları

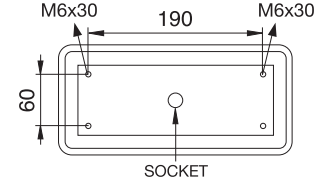

Order Number | Sipariş Kodu



Left Sol	Socket Type Bağlantı Tipi	Right Sağ	
0153LLSK71	Iveco Socket Type 	0153LRSB71	10 pcs Adet 23x70x31,5 cm ~9,5 kg
0153LLSK61	With Gromet and Cable (30 cm) 	0153LRSB61	18 pcs Adet 43x57x35 cm ~9,5 kg
0153LLSK74	AMP Socket Type 	0153LRSB74	18 pcs Adet 43x57x35 cm ~9,5 kg

Only Lens | Sadece Cam



0153CLSK

0153CRSB



40 pcs Adet
28,5x54x34,5 cm
~10 kg

Multifunction Tail Lamp

Çok Fonksiyonlu Kuyruk Lambası

0029

Functions Reverse, Stop, Position, Rear Fog, Indicator, Num. Plate**Fonksiyonlar** Geri Vites, Stop, Pozisyon, Arka Sis, Sinyal, Plaka

Fastening Bolts | Bağlantı Civataları

0029LLSK60 - 0029LLSB60

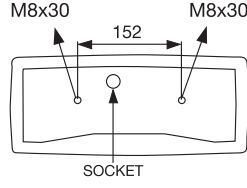
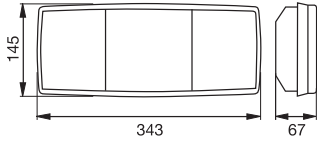

Order Number | Sipariş Kodu

Left
Sol

0029LLSK60

Right
Sağ

0029LRSB60

30 pcs Adet
43x82x36,5 cm
~20,2 kg

Only Lens | Sadece Cam



0029CUSK

30 pcs Adet
30x43x38 cm
~8,5 kg

0029CUSB

30 pcs Adet
30x43x38 cm
~8,5 kg

0221

Multifunction Tail Lamp

Çok Fonksiyonlu Kuyruk Lambası



Functions Reverse, Stop, Position, Reflector, Rear Fog, Indicator, Num. Plate

Fonksiyonlar Geri Vites, Stop, Pozisyon, Reflektör, Arka Sis, Sinyal, Plaka

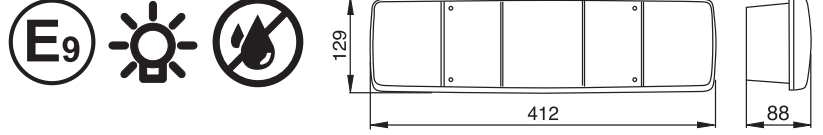

Order Number | Sipariş Kodu



Left Sol	Socket Type Bağlantı Tipi	Right Sağ	
0221LL60	With Gromet	0221LR60	24 pcs Adet 80x39x44 cm ~21 kg
0221LL61	With Gromet & Cable (30 cm)	0221LR61	24 pcs Adet 80x39x44 cm ~22 kg

Only Lens | Sadece Cam



0221CUSB



20 pcs Adet 27x29x46 cm ~6,2 kg

Fastening Bolts | Bağlantı Civataları

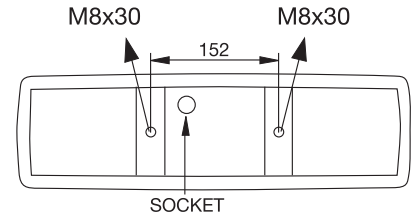

Hamburger Type Rear Lamp Hamburger Tip Arka Lamba

Order Number | Sipariş Kodu

Left Sol	Right Sağ
0021LL	0021LR
40 pcs Adet	42x57x35 cm ~15,15 kg

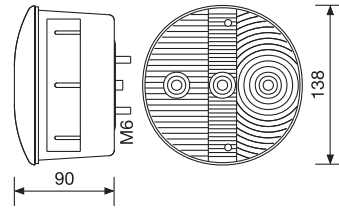

*Left lamp includes numberplate functions.

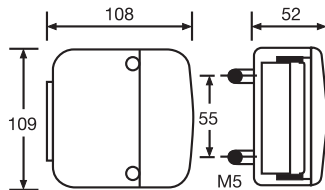

*Right lamp includes numberplate functions.



Caravan Lamp | Karavan Lambası

Order Number | Sipariş Kodu

Left Sol	Right Sağ
0076LLSK60	0076LRSK60
100 pcs Adet	42x57x35 cm ~20,08 kg

Multifunction Tail Lamp

Çok Fonksiyonlu Kuyruk Lambası

0182

Functions Reverse, Stop, Position, Indicator

Fonksiyonlar Geri Vites, Stop, Pozisyon, Sinyal

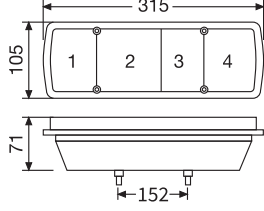

Fastening Bolts | Bağlantı Civataları

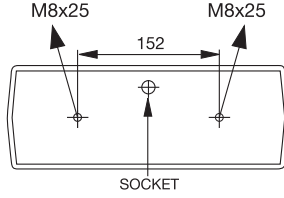

Order Number | Sipariş Kodu



0182LU60



36 pcs Adet
43x82x36,5 cm
~20,5 kg

Only Lens | Sadece Cam



0182CU



40 pcs Adet
28,5x54x34,5 cm
~6,4 kg

Functions Reverse, Stop, Position, Indicator

Fonksiyonlar Geri Vites, Stop, Pozisyon, Sinyal

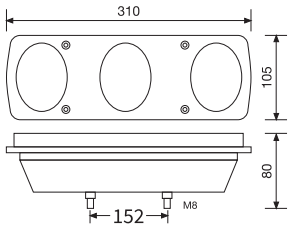

Fastening Bolts | Bağlantı Civataları

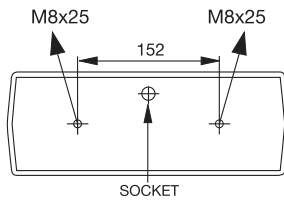

Order Number | Sipariş Kodu



0214LU60



36 pcs Adet
43x82x36,5 cm
~23,8 kg

Only Lens | Sadece Cam



0214CU



100 pcs Adet
41x48x48 cm
~17 kg

0100

Multifunction Tail Lamp

Çok Fonksiyonlu Kuyruk Lambası



Functions Reverse, Stop, Position, Reflector, Rear Fog, Indicator, Num. Plate

Fonksiyonlar Geri Vites, Stop, Pozisyon, Reflektör, Arka Sis, Sinyal, Plaka

Fastening Bolts | Bağlantı Civataları

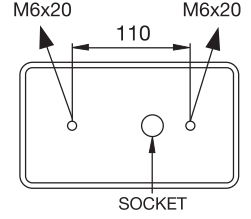
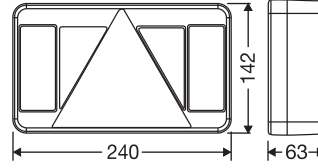

Order Number | Sipariş Kodu



Left
Sol

Socket Type
Bağlantı Tipi

Right
Sağ



0100LL51

With Gromet & Cable (30 cm)



0100LR51

40 pcs Adet
41x58x53 cm
~31,3 kg

0100LL74

AMP Socket Type



0100LR74

40 pcs Adet
41x58x53 cm
~26 kg

Only Lens | Sadece Cam



0100CL

0100CR



40 pcs Adet
80x39x44 cm
~10,8 kg

Headlight

Far

Order Number Sipariş Kodu	
Left Sol	Right Sağ

0801FL

0801FR

1 pcs Adet
28x44x27 cm
~4,95 kg

1 pcs Adet
28x44x27 cm
~4,80 kg



Left | Sol



Right | Sağ

Headlight Cover

Far Kapağı

Order Number Sipariş Kodu	
Left Sol	Right Sağ

0803YLT

0803YRT

10 pcs Adet
42,5x72x71,5 cm
~11 kg



Left | Sol



Right | Sağ

Headlight Housing

Far Yuvası

Order Number Sipariş Kodu	
Left Sol	Right Sağ

0801YL01T

0801YR01T

5 pcs Adet
59x70x78 cm
~12,85 kg

5 pcs Adet
59x70x78 cm
~12,60 kg



Left | Sol



Right | Sağ

Headlight Rim

Far Çerçevesi

Order Number Sipariş Kodu	
Left Sol	Right Sağ

0801YL025BYT

0801YR025BYT

10 pcs Adet
37x37x44 cm
~3 kg



Left | Sol



Right | Sağ



Driving Beam Reflection Body Set
Uzun Far Göbeği

Order Number Sipariş Kodu	
Left Sol	Right Sağ

0801YL032VKT

0801YR032VKT



50 pcs Adet
41,5x56,5x42 cm
~10,9 kg



Driving Beam Reflection Body Set
Uzun Far Göbeği

Order Number Sipariş Kodu	
Left Sol	Right Sağ

0801YL033VKT

0801YR033VKT



50 pcs Adet
29x82,5x49,5 cm
~17,7 kg



Passing Beam Reflection Body Set
İç Mercek Gövdesi

Order Number Sipariş Kodu	
Left Sol	Right Sağ

0801YL031VKT

0801YR031VKT



50 pcs Adet
41x48x48 cm
~9,52 kg



Passing Beam Lens
Mercek

Order Number Sipariş Kodu

0801Y02SC

Passing Beam Support Repair Kit

İç Mercek Gövdesi

Order Number Sipariş Kodu	
Left Sol	Right Sağ

0801YL30TT**0801YR30TT**

40 pcs Adet
41,5x56,5x42 cm
~6,15 kg



Passing Beam Complete Repair Kit

İç Mercek Gövde Takımı

Order Number Sipariş Kodu	
Left Sol	Right Sağ

0801YL02TT**0801YR02TT**

20 pcs Adet
41,5x56,5x42 cm
~12 kg



Lens Fixing Frame for Passing Beam

Mercek Halkası

Order Number Sipariş Kodu

0801Y83

Frame for Function Bodies

Çerçeve

Order Number Sipariş Kodu	
Left Sol	Right Sağ

0801YL03VK**0801YR03VK**

10 pcs Adet
41,5x56,5x42 cm
~4,70 kg



0303

Multifunction Tail Lamp

Çok Fonksiyonlu Kuyruk Lambası



Functions Reverse, Stop, Side Marker, Position, Reflector, Rear Fog, Indicator, Num. Plate, End Outline Marker

Fonksiyonlar Geri Vites, Stop, Yan Marker, Pozisyon, Reflektör, Arka Sis, Sinyal, Plaka, Uç Yan Marker

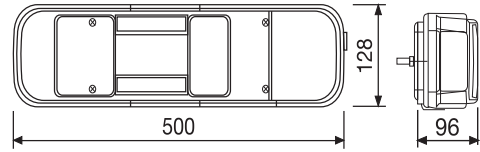

Order Number | Sipariş Kodu



Left
Sol

0303LL742



Right
Sağ

0303LR742



18 pcs Adet
40,5x76x52 cm
~23,7 kg

Only Lens | Sadece Cam



0303CU



22 pcs Adet
52,5x78x31 cm
~12,6 kg

Fastening Bolts | Bağlantı Civataları

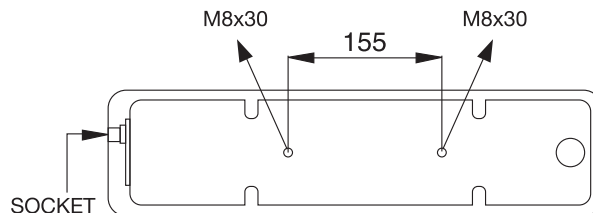

Multifunction Tail Lamp

Çok Fonksiyonlu Kuyruk Lambası

0099

Functions Reverse, Stop, Side Marker, Position, Reflector, Rear Fog, Indicator, Num. Plate, End Outline Marker

Fonksiyonlar Geri Vites, Stop, Yan Marker, Pozisyon, Reflektör, Arka Sis, Sinyal, Plaka, Uç Yan Marker

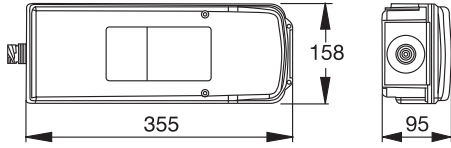

Order Number | Sipariş Kodu



Left
Sol

0099LL742



Right
Sağ

0099LR742



16 pcs Adet
40x55x39 cm
~17 kg

Only Lens | Sadece Cam



0099CU



50 pcs Adet
51x60,5x46,5 cm
~17,1 kg

Fastening Bolts | Bağlantı Civataları

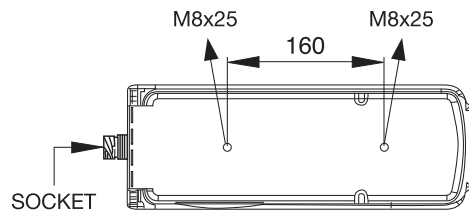

0093

Multifunction Tail Lamp

Çok Fonksiyonlu Kuyruk Lambası

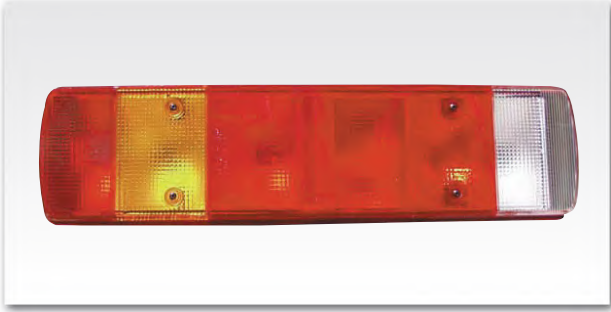

Functions Reverse, End-Outline Marker, Stop, Side Marker, Position, Reflector, Rear Fog, Indicator, Num. Plate

Fonksiyonlar Geri Vites, Uç Yan Marker, Stop, Yan Marker, Pozisyon, Reflektör, Arka Sis, Sinyal, Plaka

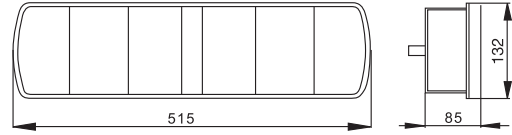

Order Number | Sipariş Kodu



Left Sol	Socket Type Bağlantı Tipi	Right Sağ	
0093LL72	Schlemmer Socket Type	0093LR72	18 pcs Adet 40,5x76x52 cm ~21,1 kg
0093LL73	Austrian Blade Socket Type	0093LR73	18 pcs Adet 40,5x76x52 cm ~21,1 kg
0093LL74	AMP Socket Type	0093LR74	18 pcs Adet 40,5x76x52 cm ~21,2 kg
0093LL90	Blind Tap Socket Type	0093LR90	18 pcs Adet 40,5x76x52 cm ~22 kg

Only Lens | Sadece Cam



0093CU



20 pcs Adet
30x30x56 cm
~7,8 kg

Fastening Bolts | Bağlantı Civataları

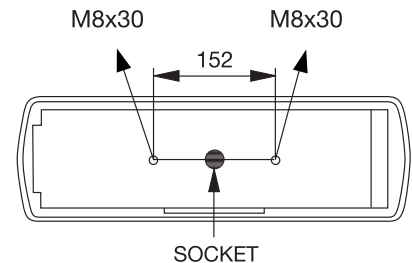

Multifunction Tail Lamp

0093

Çok Fonksiyonlu Kuyruk Lambası

Functions Reverse, End-Outline Marker, Stop, Side Marker, Position, Reflector, Rear Fog, Indicator, Num. Plate

Fonksiyonlar Geri Vites, Uç Yan Marker, Stop, Yan Marker, Pozisyon, Reflektör, Arka Sis, Sinyal, Plaka

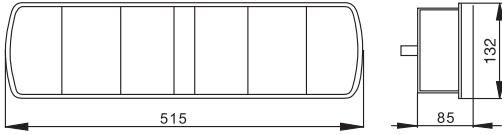
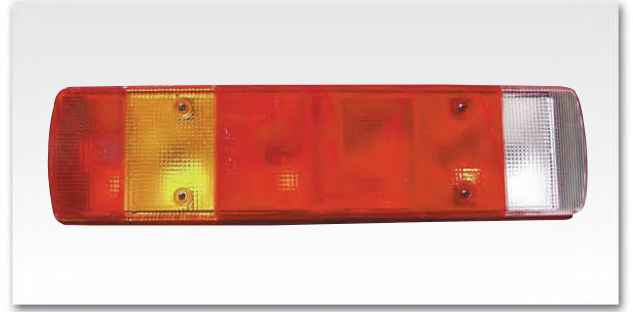

Order Number | Sipariş Kodu

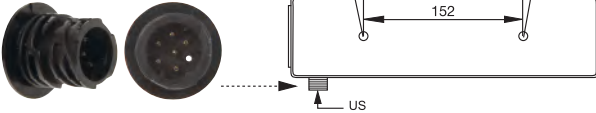
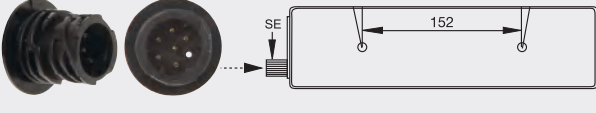
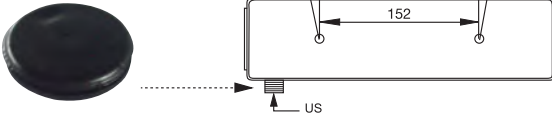
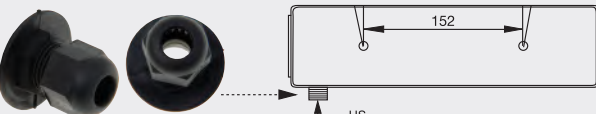
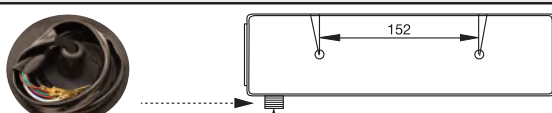

Left Sol	Socket Type Bağlantı Tipi	Right Sağ	
0093LL741 US Type AMP		0093LR741	18 pcs Adet 40,5x76x52 cm ~21,9 kg
0093LL742 SE Type AMP		0093LR742	18 pcs Adet 40,5x76x52 cm ~24,2 kg
0093LL901 US Type Blind Socket		0093LR901	18 pcs Adet 40,5x76x52 cm ~18,9 kg
0093LL501 US Universal Socket and Cable		0093LR501	18 pcs Adet 40,5x76x52 cm ~18,7 kg
0093LL511 US Universal Socket Type		0093LR511	18 pcs Adet 40,5x76x52 cm ~22 kg

Only Lens | Sadece Cam



0093CU



20 pcs Adet
30x30x56 cm
~7,8 kg

Fastening Bolts | Bağlantı Civataları

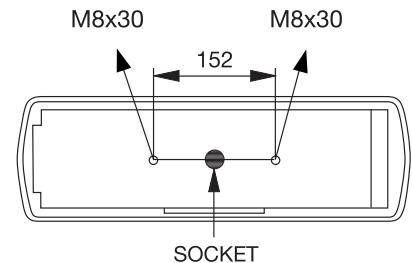

0093

Multifunction Tail Lamp

Çok Fonksiyonlu Kuyruk Lambası





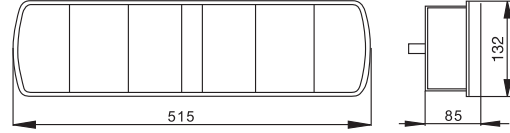

Functions Reverse, End-Outline Marker, Stop, Side Marker, Position, Reflector, Rear Fog, Indicator, Num. Plate

Fonksiyonlar Geri Vites, Uç Yan Marker, Stop, Yan Marker, Pozisyon, Reflektör, Arka Sis, Sinyal, Plaka



Order Number | Sipariş Kodu

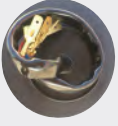

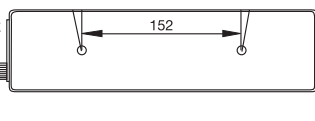
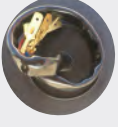
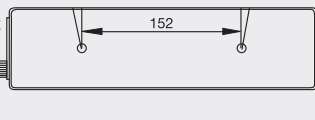
Left Sol	Socket Type Bağlantı Tipi	Right Sağ	
0093LL601 US Gromet Type			0093LR601 18 pcs Adet 40,5x76x52 cm ~22,1 kg
0093LL611 US Gromet and Cable (30 cm)			0093LR611 18 pcs Adet 40,5x76x52 cm ~22,4 kg
0093LL602 SE Gromet Type			0093LR602 18 pcs Adet 40,5x76x52 cm ~23,3 kg
0093LL612 SE Gromet and Cable (30 cm)			0093LR612 18 pcs Adet 40,5x76x52 cm ~19,7 kg

Only Lens | Sadece Cam



0093CU



20 pcs Adet
30x30x56 cm
~7,8 kg

Fastening Bolts | Bağlantı Civataları

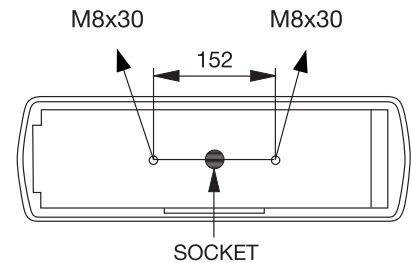

Multifunction Tail Lamp

0093

Çok Fonksiyonlu Kuyruk Lambası

Functions Reverse, End-Outline Marker, Stop, Side Marker, Position, Reflector, Rear Fog, Indicator, Num. Plate

Fonksiyonlar Geri Vites, Uç Yan Marker, Stop, Yan Marker, Pozisyon, Reflektör, Arka Sis, Sinyal, Plaka

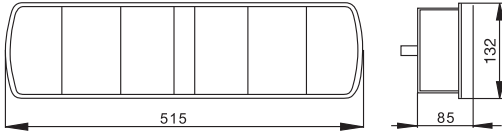

Order Number | Sipariş Kodu



Left Sol	Socket Type Bağlantı Tipi	Right Sağ	
0093LL50 Universal Gromet		0093LR50	18 pcs Adet 40,5x76x52 cm ~22,1 kg
0093LL51 Universal Gromet with Cable (60 cm)		0093LR51	18 pcs Adet 40,5x76x52 cm ~24,2 kg
0093LL60 With Gromet Type		0093LR60	18 pcs Adet 40,5x76x52 cm ~23,3 kg
0093LL61 With Gromet and Cable (30 cm)		0093LR61	18 pcs Adet 40,5x76x52 cm ~24,1 kg

Only Lens | Sadece Cam



0093CU



20 pcs Adet
30x30x56 cm
~7,8 kg

Fastening Bolts | Bağlantı Civataları

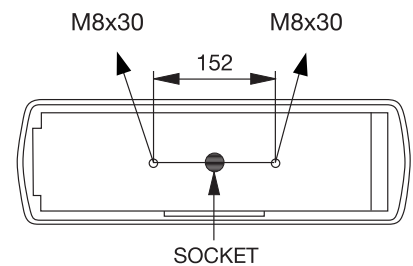



Front Side Signal Lamp
Ön Kenar Sinyal Lambası

Order Number Sipariş Kodu	
Left Sol	Right Sağ

0858LL

0858LR

50 pcs Adet
38,5x56x35 cm
~8,9 kg

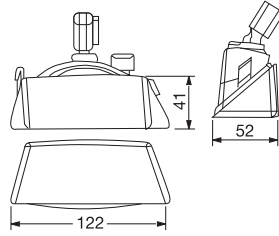
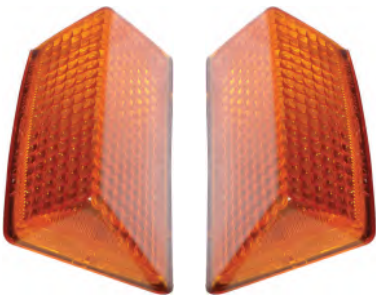

Front Side Signal Lamp (without Frame)
Ön Kenar Sinyal Lambası (Çerçevesiz)

Order Number Sipariş Kodu	
Left Sol	Right Sağ

0256LL

0256LR

100 pcs Adet
45x52x25 cm
~9,9 kg

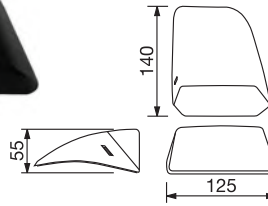

Front Side Signal Lamp Frame
Ön Kenar Sinyal Lamba Çerçevesi

Order Number Sipariş Kodu	
Left Sol	Right Sağ

0856FL

0856FR

48 pcs Adet
38x40x26 cm
~5,7 kg

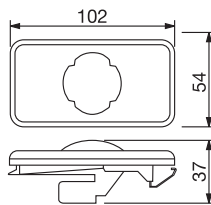

Side Marker Lamp with LED (4 LEDs)
LEDli Yan İşaret Lambası (4 LEDli)

Order Code Ürün Kodu

0656LUS

100 pcs Adet
29x40x25 cm
~4,6 kg

0,48W/24V

Front Signal Lamp Truck

Tır Ön Sinyal Lambası

Order Number Sipariş Kodu	
Without Socket Soketsiz	With Socket Soketli

3353LS (Yellow)**3353LAS** (Yellow)**3353LB** (White-Yellow)**3353LAB** (White-Yellow)

60 pcs Adet
29x82x48,5 cm
~18 kg



Front Signal Lamp Truck

Tır Ön Sinyal Lambası

Order Number Sipariş Kodu	
Without Socket Soketsiz	With Socket Soketli

3352LS**3352LAS**

60 pcs Adet
29x82x48,5 cm
~18 kg



Front Lamp Truck

Tır Ön Lambası

Order Number Sipariş Kodu	
Without Socket Soketsiz	With Socket Soketli

3354L**3354LA**

50 pcs Adet
51x61x49 cm
~13,9 kg





Cabin Top-Ceiling Lamp
Kabin Üstü Tavan Lambası

Order Number | Sipariş Kodu

Clear | Şeffaf

Amber | Amber

0753LUB

0753LUS

64 pcs Adet
45x50x25 cm
~6,4 kg

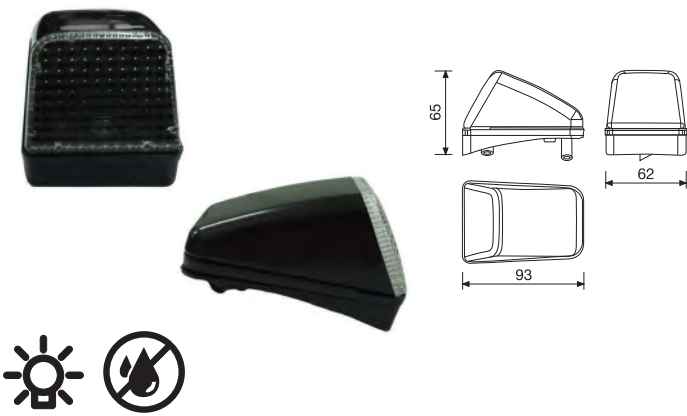

Cabin Top-Middle Lamp
Kabin Üstü Orta Lambası

Order Number | Sipariş Kodu

Clear | Şeffaf

Amber | Amber

0752LUB

0752LUS

64 pcs Adet
45x50x25 cm
~9 kg



Cabin Top-Ceiling Corner Lamp
Kabin Üstü Tavan Köşe Lambası

Order Number | Sipariş Kodu

Left Clear
Sol Şeffaf

Right Clear
Sağ Şeffaf

Left Amber
Sol Amber

Right Amber
Sağ Amber

0754LLB

0754LRB

0754LLS

0754LRS

64 pcs Adet
45x50x25 cm
~15,5 kg



Front Side LED Signal Lamp
LEDli Ön Sinyal Lambası

Order Number | Sipariş Kodu

Left Clear
Sol Şeffaf

Right Clear
Sağ Şeffaf

0756LLEDL

0756LLEDR

64 pcs Adet
45x50x25 cm
~19,5 kg



Headlight with Front Side Signal Lamp

Far Ön Sinyal Lambası

Order Number Sipariş Kodu	
Left Sol	Right Sağ
0810231FL	0810231FR
1 pc Adet 17,5x55x20,5 cm ~3,10 kg	1 pc Adet 17,5x55x20,5 cm ~3,30 kg



Right | Sağ



Left | Sol



Headlight with Front Side Signal Lamp

Far Ön Sinyal Lambası

Order Number Sipariş Kodu			
Order Left Sol Ürün	Left Glass Sol Cam	Order Right Sağ Ürün	Right Glass Sağ Cam
0810FL	08120SCL	0810FR	08120SCR
1 pc Adet 17,5x55x20,5 cm ~2,8 kg		1 pc Adet 17,5x55x20,5 cm ~3,00 kg	



Right | Sağ



Left | Sol



Front Signal Lamp

Ön Sinyal Lambası

Order Number Sipariş Kodu			
Without Socket Left Sol Soketsiz	Without Socket Right Sağ Soketsiz	With Socket Left Sol Soketli	With Socket Right Sağ Soketli
0231LL	0231LR	0231LLA	0231LRA



Right | Sağ



Left | Sol

Bulb Holder Set

Ampul Duy Takımı

Order Number Sipariş Kodu
QKT29



Side Marker Lamp with LED (4 LEDs)

LEDli Yan İşaret Lambası (4 LEDli)

Order Number Sipariş Kodu
0253LUS25
27 pcs Adet 19x37x16 cm ~2 kg



12V/24V

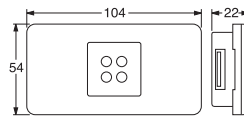

Socket Type | Soket Tipi



Side Indicator Lamp | Yan Sinyal Lambası

Order Number Sipariş Kodu	
With Socket Soketli	Without Socket Soketsiz
0274LUS	0274LUSQ
35 pcs Adet 29x36x32 cm ~5 kg	



24V/21W

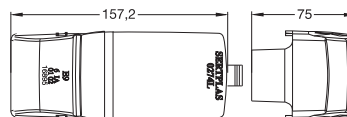



Right | Sağ



Left | Sol



Headlight

Far

Order Number		Sipariş Kodu	
Left Sol	Left Glass Sol Cam	Right Sağ	Right Glass Sağ Cam

0369FL 0369SCL 0369FR 0369SCR

1 pc Adet
24x42x25 cm
~3,00 kg



Right | Sağ



Left | Sol



Headlight with Front Side Signal Lamp

Far Ön Sinyal Lambası

Order Number		Sipariş Kodu	
Left Sol		Right Sağ	

DM0379LL

DM0379LR



Right | Sağ



Left | Sol



Front Lamp

Ön Lambası

Order Number		Sipariş Kodu	
Without Socket Left Sol Soketsiz	Without Socket Right Sağ Soketsiz	With Socket Left Sol Soketli	With Socket Right Sağ Soketli

0364LGL

0364LGR

0364LL

0364LR

Multifunction Tail Lamp

Çok Fonksiyonlu Kuyruk Lambası

0393

Functions Reverse, Stop, Side Marker, Position, Reflector, Rear Fog, Indicator, Num. Plate, End-Outline Marker

Fonksiyonlar Geri Vites, Stop, Yan Marker, Pozisyon, Reflektör, Arka Sis, Sinyal, Plaka, Uç Yan Marker

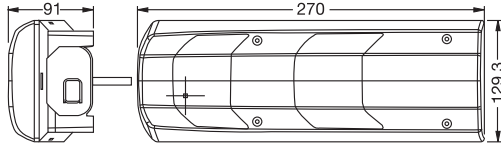

Order Number | Sipariş Kodu



Left
Sol

0393LL76



Right
Sağ

0393LR76



With Buzzer
Buzzerli

0393LR76B



20 pcs Adet
41x58x53 cm
~18,4 kg



16 pcs Adet
41x48x46 cm
~18,5 kg

Only Lens | Sadece Cam



0393CU



24 pcs Adet
41,5x48,5x38 cm
~8,4 kg

Fastening Bolts | Bağlantı Civataları

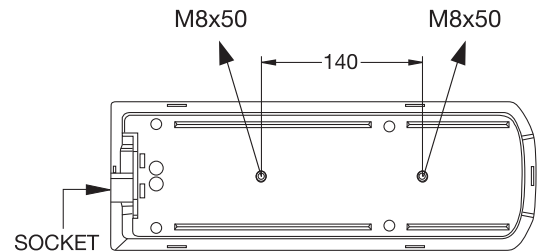

0254 MODEL: AFTER 2011

Multifunction Tail Lamp

Çok Fonksiyonlu Kuyruk Lambası



Functions Reverse, Stop, Side Marker, Position, Reflector, Rear Fog, Indicator, Num. Plate, End-Outline Marker

Fonksiyonlar Geri Vites, Stop, Yan Marker, Pozisyon, Reflektör, Arka Sis, Sinyal, Plaka, Uç Yan Marker

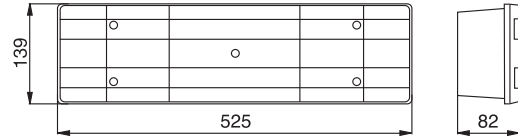

Order Number | Sipariş Kodu



Left
Sol

Right
Sağ

With Buzzer
Buzzerli

0254LL7427

0254LR7427

0254LR7427B



16 pcs Adet
41x58x53 cm
~20,2 kg

16 pcs Adet
41x58x53 cm
~21,7 kg

Only Lens | Sadece Cam

Fastening Bolts | Bağlantı Civataları



0254CL

0254CR

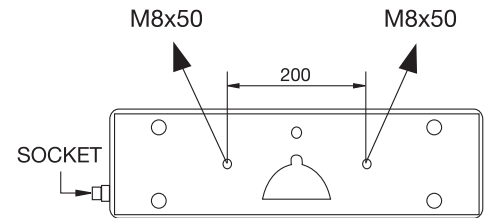

20 pcs Adet
30x45x57 cm
~9,7 kg

Conn. Points	Sol/Left		Sağ/Right		
	Fonksiyonlar	Functions	Fonksiyonlar	Functions	
1	Şase	Earth	1	Şase	Earth
2	Pozisyon	Position	2	Pozisyon	Position
3	Geri Vites	Reverse	3	Geri Vites	Reverse
4	Sinyal	Signal	4	Sinyal	Signal
5	Stop	Stop	5	Stop	Stop
6	Sis	Fog	6	Boş	Not Used
7	Yedek	Auxiliary	7	Boş	Not Used

Multifunction Tail Lamp

0254

Çok Fonksiyonlu Kuyruk Lambası

Functions Reverse, Stop, Side Marker, Position, Reflector, Rear Fog, Indicator, Num. Plate, End-Outline Marker

Fonksiyonlar Geri Vites, Stop, Yan Marker, Pozisyon, Reflektör, Arka Sis, Sinyal, Plaka, Uç Yan Marker

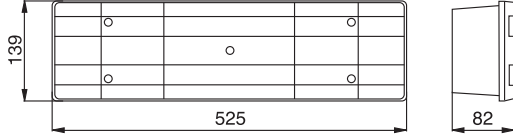

Order Number | Sipariş Kodu



Left
Sol

0254LL742



Right
Sağ

0254LR742



With Buzzer
Buzzerli

0254LR7426



16 pcs Adet
41x58x53 cm
~24,6 kg



16 pcs Adet
41x58x53 cm
~24,3 kg

Only Lens | Sadece Cam



0254CL



0254CR



20 pcs Adet
30x45x57 cm
~9,7 kg

Fastening Bolts | Bağlantı Civataları

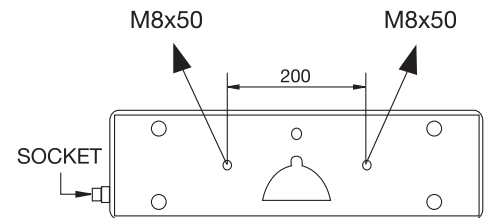

0254

Multifunction Tail Lamp

Çok Fonksiyonlu Kuyruk Lambası



Functions Reverse, Stop, Side Marker, Position, Reflector, Rear Fog, Indicator, Num. Plate, End-Outline Marker

Fonksiyonlar Geri Vites, Stop, Yan Marker, Pozisyon, Reflektör, Arka Sis, Sinyal, Plaka, Uç Yan Marker

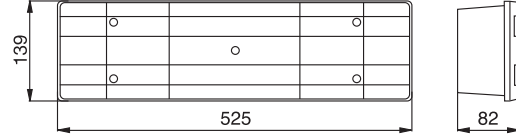

Order Number | Sipariş Kodu



Left
Sol

Right
Sağ

With Buzzer
Buzzerli

0254LL61 (with 30 cm Cable)

0254LR61 (with 30 cm Cable)

0254LL616 (with 30 cm Cable)

0254LL60 (witout Cable)

0254LR60 (witout Cable)

0254LR616 (witout Cable)



16 pcs Adet
41x58x53 cm
~23,9 kg

16 pcs Adet
41x58x53 cm
~24,1 kg

Only Lens | Sadece Cam

Fastening Bolts | Bağlantı Civataları



0254CL

0254CR

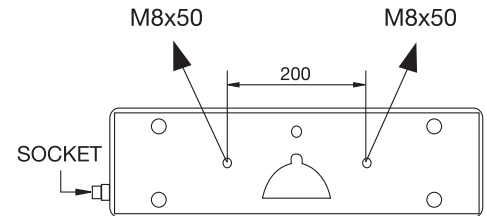

20 pcs Adet
30x45x57 cm
~9,7 kg

Side Indicator Lamp

Sinyal Lambası

Order Number Sipariş Kodu	
Left Sol	Right Sağ

0248LL**0248LR**

50 pcs Adet
29x40x23 cm
~5,9 kg

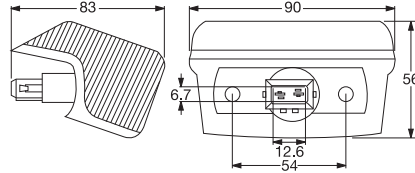

Front Side Signal Lamp

Ön Kenar Sinyal Lambası

Order Number Sipariş Kodu

0006LUS

80 pcs Adet
29x40x23 cm
~5,2 kg

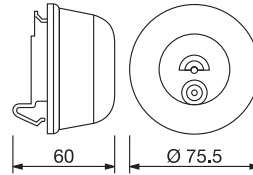

Front Side Signal Lamp

Ön Kenar Sinyal Lambası

Order Number Sipariş Kodu

0022LU

50 pcs Adet
29x36x32 cm
~5,4 kg

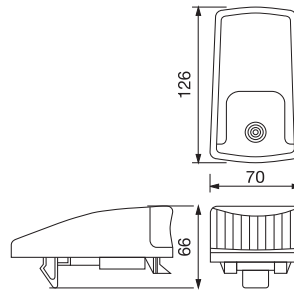

Bus Signal Lamp

Otobüs Sinyal Lambası

Order Number Sipariş Kodu	Only Lens Sadece Cam
------------------------------	-------------------------

0263LUS**0263CUS**

50 pcs Adet
34x38x29 cm
~7,3 kg

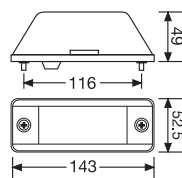

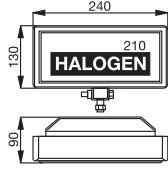

Fog Lamp 210 Type Plastic Housing
Sis Lambası 210 Tip Plastik Gövde

Order Number | Sipariş Kodu

Black Frame (Amber) Siyah Çerçevesi (Amber)	Black Frame (Clear) Siyah Çerçevesi (Şeffaf)
--	---

0165LUS

0165LUB

Order Number | Sipariş Kodu

Chrome Plated (Amber) Krom Kaplama Çerçevesi (Amber)	Chrome Plated (Clear) Krom Kaplama Çerçevesi (Şeffaf)
---	--

0184LUS

0184LUB

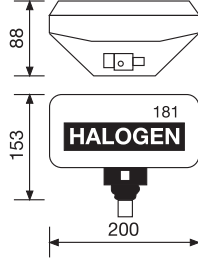

Fog Lamp 181 Type Plastic Housing
Sis Lambası 181 Tip Plastik Gövde

Order Number | Sipariş Kodu

Yellow Sarı	Clear Şeffaf
---------------	----------------

0164LUS

0164LUB

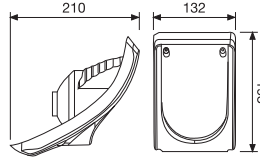

Bus Rear Corner Lamp

Otobüs Arka Köşe Lambası

Order Number | Sipariş Kodu

Position and Stop Pozisyon ve Stop	Indicator Sinyal	Reverse Geri Vites
---------------------------------------	---------------------	-----------------------

0252LUK

0252LUS

0252LUB

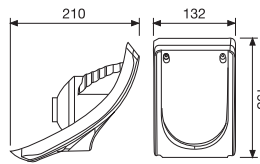

Bus Rear Corner Lamp (with LED)
Otobüs Arka Köşe Lambası (LEDli)

Order Number | Sipariş Kodu

Position Pozisyon	Fog Sis	Indicator Sinyal
---------------------	-----------	--------------------

0252LLEDKP

0252LLEDKS

0252LLEDS

Order Number | Sipariş Kodu

Stop Stop	Reverse Geri Vites
-------------	----------------------

0252LLEDK

0252LLEDB

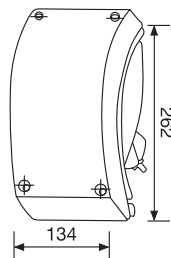
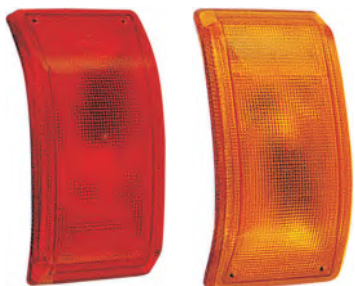

Corner Lamp for Bus
Otobüs Köşe Lambası

Order Number | Sipariş Kodu

Amber Amber	Red Kırmızı	Clear Şeffaf
---------------	---------------	----------------

0183LUS

0183LUK

0183LUB

Order Number | Sipariş Kodu

Lens (Amber) Cam (Amber)	Lens (Red) Cam (Kırmızı)	Lens (Clear) Cam (Şeffaf)
-----------------------------	-----------------------------	------------------------------

0183CUS

0183CUK

0183CUB

Headlight Complete

Far Takımı

Order Number Sipariş Kodu	
Left Sol	Right Sağ

037071FL**037071FR**

Only Lens Sadece Cam	
Left Sol	Right Sağ

0370FSCL**0370FSCR**

RIGHT



LEFT



Signal Lamp

Sinyal Lambası

Order Number Sipariş Kodu	
Left Sol	Right Sağ

0371LL**0371LR**

RIGHT



LEFT



Foot Step Lamp

Otobüs Arka Köşe Lambası

Order Number Sipariş Kodu	
Without Socket Soketsiz	With Socket Soketli

0074LUC**0074LU**

0197

Multifunction Tail Lamp

Çok Fonksiyonlu Kuyruk Lambası



Functions Reverse, End-Outline Marker, Stop, Side Marker, Position, Reflector, Rear Fog, Indicator, Num. Plate

Fonksiyonlar Geri Vites, Uç Yan Marker, Stop, Yan Marker, Pozisyon, Reflektör, Arka Sis, Sinyal, Plaka

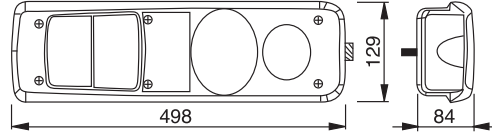

Order Number | Sipariş Kodu



Left
Sol

Socket Type
Bağlantı Tipi

Right
Sağ

0197LL

With gromet & Cable (30 cm)



0197LR



18 pcs Adet
40,5x76x52 cm
~21 kg

Only Lens | Sadece Cam

Fastening Bolts | Bağlantı Civataları



0197CU

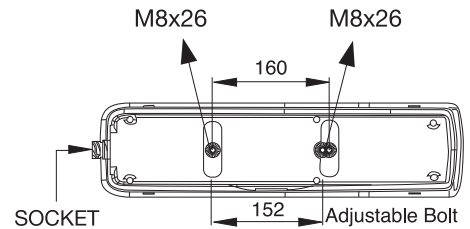

22 pcs Adet
52,5x78,5x31 cm
~10,3 kg

Multifunction Tail Lamp

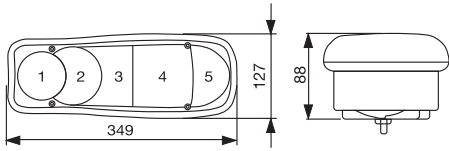

Çok Fonksiyonlu Kuyruk Lambası

0094

Functions Reverse, Stop, Position, Rear Fog, Indicator, Num. Plate**Fonksiyonlar** Geri Vites, Stop, Pozisyon, Arka Sis, Sinyal, Plaka

Order Number | Sipariş Kodu



Left Sol	Socket Type Bağlantı Tipi	Right Sağ	
0094LL51	Universal Gromet with Cable (60 cm)		0094LR51 18 pcs Adet 40,5x75,5x37 cm ~16,4 kg
0094LL74	AMP Socket Type		0094LR74 18 pcs Adet 40,5x75,5x37 cm ~15,8 kg
0094LL90	Blind Tap Type Socket		0094LR90 18 pcs Adet 40,5x75,5x37 cm ~15,6 kg

Only Lens | Sadece Cam

Fastening Bolts | Bağlantı Civataları

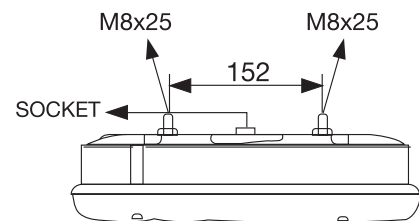

0094CU

28 pcs Adet
26x43x38 cm
~7 kg

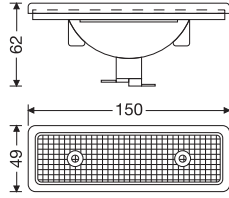

Front Signal, Position Lamp
Ön Sinyal, Pozisyon Lambası

Order Number
Sipariş Kodu

7501LU

100 pcs Adet
45x50x25 cm
~10,4 kg

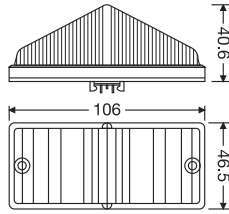

Position Lamp
(Red/Clear, Red and different colours are available)
Pozisyon Lambası
(Kırmızı/Şeffaf, Kırmızı ve farklı renklerde üretilebilir.)

Order Number
Sipariş Kodu

0112LU

120 pcs Adet
45x50x25 cm
~8,4 kg

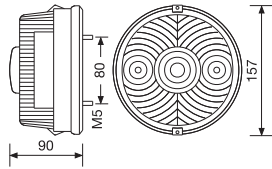

Hamburger Type Rear Lamp
Hamburger Tip Arka Lamba

Order Number
Sipariş Kodu

0320LU

50 pcs Adet
51x60,5x46,5 cm
~2,8 kg

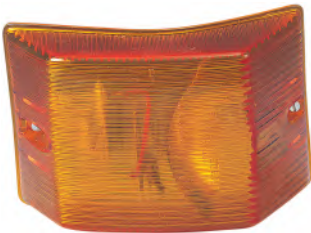

Signal Lamp
Sinyal Lambası

Order Number
Sipariş Kodu

0257LU

30 pcs Adet
41,5x56,5x42,5 cm
~4,2 kg

Only Lens
Sadece Cam

0257CU



Signal Lamp Lens
Sinyal Lamba Camı

Order Number | Sipariş Kodu

Left | Sol

Right | Sağ

0208CL

0208CR

100 pcs Adet
51x60,5x46,5 cm
~13 kg

Front, Rear Mudguard Panel Front Left
Ön Çamurluk, Ön Parça Sol
Order No: **9803PDM**



Front, Rear Mudguard Panel Front Right
Ön Çamurluk, Ön Parça Sağ
Order No: **9804PDM**



Rear Mudguard Panel Middle Part
Arka Çamurluk Orta Parça
Order No: **9802PDM**



Rear Mudguard Panel Front / Back
Arka Çamurluk Ön veya Arka Parça
Order No: **9801PDM**



Front Wheel Rear Mudguard
Ön Tekerlek Arka Yastık
Order No: **9808.P.DM**



Rear Front Mudguard (New Type)
Arka Ön Çamurluk (Yeni Tip)
Order No: **9819PDM**



Step Panel | Basamak Paneli

Order No:
9807PDMR (Right)
9807PDML (Left)



Upper Step Big Type
Metal Büyük Basamak

Order No: **9701MDM**

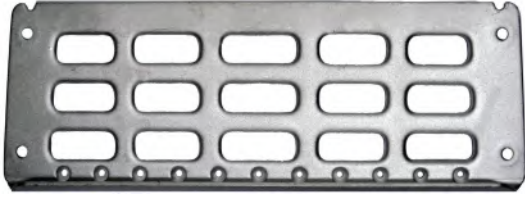

Lower Step Small Type
Metal Küçük Basamak

Order No:
9702MDMR (Right)
9702MDML (Left)



Rear Mudguard Panel Middle Part
Orta Çamurluk Parçası

Order No: **9805PDM**



Rear Mudguard Panel Front / Rear
Arka Çamurluk Ön veya Arka Parça

Order No:
9806P1DM



Upper Step
Üst Basamak

Order No: **9706MDM**



Lower Step
Küçük Basamak

Order No: **9707MDM**



Rear Half Mudguard
Arka Yarım Çamurluk

Order No:
9813PDM (Right)
9816PDM (Left)



Rear Mudguard Left
Arka Çamurluk Sol

Order No: **9818PDML**



Mudguard (Middle)
Çamurluk (Orta)

Order No : **9814PDM**



Mudguard (Rear)
Çamurluk (Arka)

Order No : **9823PDM**



Front Mudguard Front Left
Ön Üst Çamurluk Sol

Order No : **9824PDML**



Front Mudguard Front Right
Ön Üst Çamurluk Sağ

Order No : **9824PDMR**



Mudguard
Çamurluk

Order No : **9815PDM**



Rear Mudguard Rear Right
Arka Çamurluk (Sağ)

Order No : **9818PDMR**



Rear Mudguard Panel Rear Part
Arka Çamurluk Paneli Arka Bölümü

Order No : **1311**



Rear Mudguard Central
Arka Orta Çamurluk

Order No : **1310**

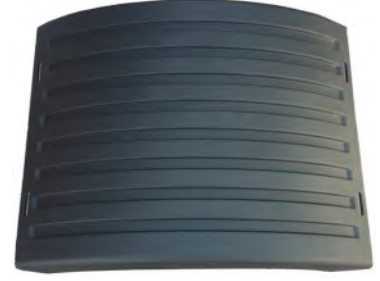

Rear Mudguard Panel Rear Part Right/Left Mounting
Arka Çamurluk Paneli Sağ/Sol Arka Montajlı

Order No :

9812PDM (Left)
9811PDM (Right)



Rear Mudguard Panel Front Part
Arka Çamurluk Paneli Ön Kısım

Order No :

9820PDM



Rear Mudguard Central
Arka Orta Çamurluk

Order No :

9809PDM



High Type Cabin Lower Step
Yüksek Tip Kabin Alt Basamağı

Order No :

9703LP1DM (Left)
9703RP1DM (Right)

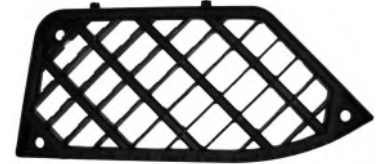

High Type Cabin Upper Step
Yüksek Tip Kabin Üst Basamağı

Order No :

9703LP2DM (Left)
9703RP2DM (Right)



Upper Step
Üst Basamak

Order No :

9704MDM



Lower Step
Alt Basamak

Order No :

9705PDM

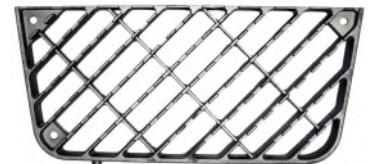

Amber Rotating Beacon with Rod Mounted 12/24V
Çubuğa Monteli Sarı Döner Lamba 12/24V

Order Number Sipariş Kodu	Only Lens Sadece Cam
0315LUS12V 0315LUS24V	0315C
20 pcs Adet 43x57x35 cm ~12,7 kg	

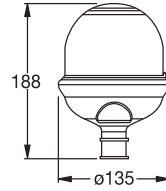

12V/24V



Amber Rotating Beacon 12/24V
Döner Lamba 12/24V

Order Number Sipariş Kodu	Only Lens Sadece Cam
0278LUS12V 0209LUS24V	0322CUS
20 pcs Adet 82x43x36 cm ~13,5 kg	

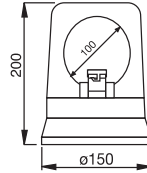

12V/24V



Amber Rotating Beacon with Magnetisid Housing
(Single Pole lighter Plug) 12/24V
Mıknatısla Monteli Sarı Döner Lamba
(Çakmak Fişlerine Uyumlu) 12/24V

Order Number Sipariş Kodu	Only Lens Sadece Cam
0269LUS12V 0271LUS24V	0322CUS
10 pcs Adet 31,5x79x25,5 cm ~11,8 kg	

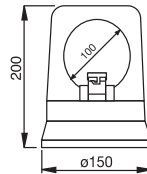

12V/24V



Amber Rotating Beacon with Rod Mounted 12/24V
Çubuğa Monteli Sarı Döner Lamba 12/24V

Order Number Sipariş Kodu	Only Lens Sadece Cam
0322LUS12V 0323LUS24V	0322CUS
30 pcs Adet 76x41x52 cm ~22,2 kg	

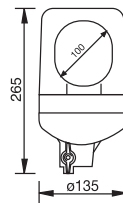

12V/24V



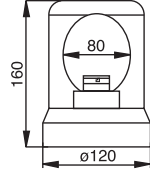

12V/24V



Amber Rotating Beacon Mirror Arm Mounted 12/24V
Arka Koluna Monteli Sarı Döner Lamba 12/24V

Order Number
Sipariş Kodu

Only Lens
Sadece Cam

0312LUS12V
0312LUS24V

0311C

30 pcs Adet
38x63x39 cm
~18 kg

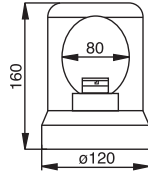

12V/24V



Amber Rotating Beacon with Magnetisid Housing
(Single Pole lighter Plug) 12/24V
Mıknatısla Monteli Sarı Döner Lamba
(Çakmak Fişlerine Uyumlu) 12/24V

Order Number
Sipariş Kodu

Only Lens
Sadece Cam

0311LUS12V
0311LUS24V

0311CUS

30 pcs Adet
38x63x39 cm
~25,6 kg

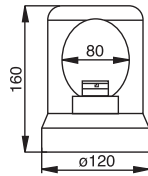

12V/24V



Amber Rotating Beacon with Three Bolts Mounted 12/24V
Üç Civatayla Monteli Sarı Döner Lamba 12/24V

Order Number
Sipariş Kodu

Only Lens
Sadece Cam

0310LUS12V
0310LUS24V

0311CUS

30 pcs Adet
38x63x39 cm
~16,2 kg

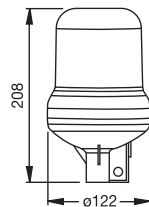

12V/24V



Amber Rotating Beacon with Rod Mounted 12/24V
Çubuğa Monteli Sarı Döner Lamba 12/24V

Order Number
Sipariş Kodu

Only Lens
Sadece Cam

0313LUS12V
0313LUS24V

0311CUS

30 pcs Adet
38x63x44 cm
~17,4 kg

12/24V LEDs Flashing Light
Mounting with Magnetic Base and Mounting with Screw

Mıknatısla Monteli Elips Yüzeyle Döner Lamba 12/24V
Manyetik Tabanlı Montaj ve Vidalı Montaj

Order Number Sipariş Kodu	
Magnetic Mıknatıslı	Screw Vidalı
0318LUS-M	0318LUS-V
20 pcs Adet 31,5x79x25,5 cm ~17,1 kg	20 pcs Adet 31,5x79x25,5 cm ~11,3 kg

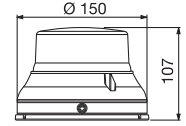
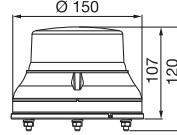

LED Flashing Lamp 12V
LEDli Çakar Lamba 12V

Order Number Sipariş Kodu
0316LUS
54 pcs Adet 41x48x45 cm ~12,3 kg

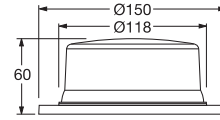

Rotating Beacon Standart Galaxy Type 12/24V
Galaxy Tip Standart Döner Lamba 12/24V

Order Number Sipariş Kodu	Only Lens Sadece Cam
0233LUS12V 0234LUS24V	0233CUS
24 pcs Adet 65x49x42 cm ~15,7 kg	

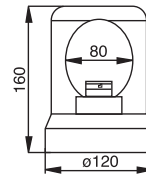

Rotating Beacon Super Galaxy Type 12/24V
Süper Galaxy Tip Döner Lamba 12/24V

Order Number Sipariş Kodu	Only Lens Sadece Cam
0289LUS12V 0232LUS24V	0289C
16 pcs Adet 100x52x54 cm ~17,84 kg	

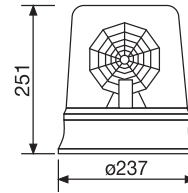

(for rotating beacons)

Order No : **0352U**



100 pcs Adet
22x36x26 cm
~20,108 kg

Order No : **0354U**



100 pcs Adet
29x40x23 cm
~24,15 kg

Order No : **0353U**



100 pcs Adet
22x36x26 cm
~21,50 kg



Galaxy Terminal Socket
Order No : **0354Y51J**



200 pcs Adet
35x13x16 cm
~5,165 kg



Spot Beam



Flood Beam

LED

- * 27W (9 Ledx3W)
- * DC 9V-60V
- * Aluminium Base
- * Polycarbonat Lens
- * Colour Temp. 6000 k
- * Life Span 20000 hours
- * 1800 lm
- * 35 cm Cable
- * M8 Screw and Nut

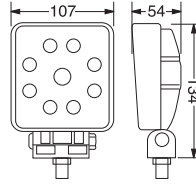

LED Work Lamp

LEDli Çalışma Lambası

Order Number | Sipariş Kodu

Flood Beam

Spot Beam

DM2609

DM2608

36 pcs Adet
29x36x32 cm
~23 kg

36 pcs Adet
29x36x32 cm
~22 kg



Spot Beam



Flood Beam

LED

- * 15W (5 Ledx3W)
- * Voltage 9-60V DC
- * Light Performance 1000 lm
- * Aluminium Base
- * Polycarbonat Lens
- * Colour Temp. 6000 k
- * Life Span 20000 hours
- * 35 cm Cable Length
- * M8 Screw&Nut

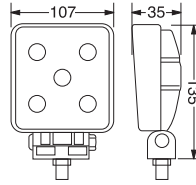

LED Work Lamp

LEDli Çalışma Lambası

Order Number | Sipariş Kodu

Flood Beam

Spot Beam

DM2597

DM2606

20 pcs Adet
35x32x27 cm
~9,8 kg

20 pcs Adet
35x32x27 cm
~9,8 kg



Spot Beam



Flood Beam

LED

- * 27W (9 Ledx3W)
- * DC 9V-60V
- * Aluminium Base
- * Polycarbonat Lens
- * Colour Temp. 6000 k
- * Life Span 20000 hours
- * 1800 lm
- * 35 cm Cable
- * M8 Screw and Nut

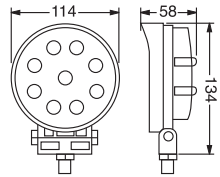

LED Work Lamp

LEDli Çalışma Lambası

Order Number | Sipariş Kodu

Flood Beam

Spot Beam

DM2610

DM2607

20 pcs Adet
29x36x32 cm
~23 kg

20 pcs Adet
29x36x32 cm
~22 kg



Flood Beam

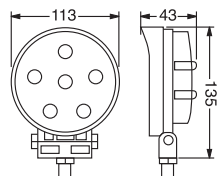

Work Lamp

Çalışma Lambası

Order Number | Sipariş Kodu

Flood Beam

DM2598

20 pcs Adet
35x32x27 cm
~10,5 kg

Work Lamp

Çalışma Lambası

Order Number
Sipariş Kodu

5113L

40 pcs Adet
49x42x49 cm
~21 kg

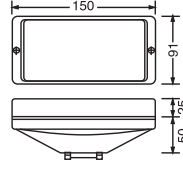

Work Lamp

Çalışma Lambası

Order Number
Sipariş Kodu

5112L

48 pcs Adet
60x50x60 cm
~27,5 kg

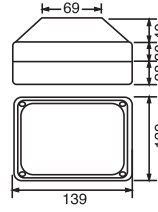

Work Lamp

Çalışma Lambası

Order Number
Sipariş Kodu

DM909HIN

40 pcs Adet
61x34x47 cm
~19,65 kg

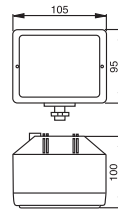

Projector HeadLamp with Parking Light Fog and Driving Type Available
Projektör Lambası (Park Işıklı) Sis ve Yol Sürüş Aydınlatma Tipleri Mevcut

Order Number | Sipariş Kodu

Ø 200 mm

Ø 200 mm

5017LUB

5020LUB

24 pcs Adet
44x59x45 cm
~25,4 kg



Amber colour also available



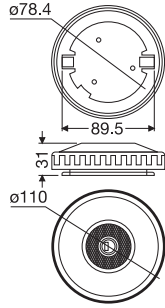

Cast Aluminium
Chrome Plated
Ø80 mm

Locking Tank Cap
Anahtarlı Depo Kapağı

Order Number
Sipariş Kodu

DM7060.YD



(with Chain)

New Type Tank Cap (Ø80 mm)
Zincirli Korumalı Depo Kapağı

Order Number
Sipariş Kodu

DM7061.YD



Locking Tank Cap (Ø80 mm) | Anahtarlı Depo Kapağı

Order Number
Sipariş Kodu

DM7085.YD

With Cover
Koruyuculu

DM7086.YD



Tank Cap | Kilitless Depo Kapağı

Order Number
Sipariş Kodu

DM7080.YD



Locking Tank Cap (Ø80 mm) | Anahtarlı Depo Kapağı

Order Number | Sipariş Kodu

DM7070.YD

Aluminium Cast, Black Plated



Locking Tank Cap (Ø60 mm), Plastic Housing
Anahtarlı Depo Kapağı

Order Number | Sipariş Kodu

M7160



Locking Tank Cap (Ø60 mm) | Anahtarlı Depo Kapağı

Order Number
Sipariş KoduWith Cover
Koruyuculu**DM7078****DM7079**

Tank Cap (Ø60 mm) | Kilitless Depo Kapağı

Order Number
Sipariş Kodu**DM7077.YD**

Radiator Cap | Radyatör Kapağı

Order Number | Sipariş Kodu

DM7088.YD

Oil Cap | Yağ Kapağı

Order Number | Sipariş Kodu

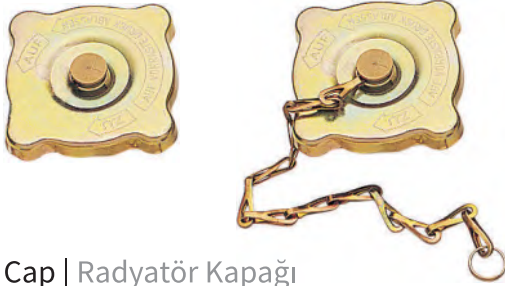
DM7087.YD

Radiator Cap | Radyatör Kapağı

Order Number | Sipariş Kodu

Without Chain | Zincirsiz

With Chain | Zincirli

DM7074**DM7073**Door Handle (Right/Left) with Key
Kapı Kolu (Sağ/Sol) Anahtarlı

Order Number | Sipariş Kodu

Left | Sol

Right | Sağ

9501LA**9501RA**

Tire Pump up Hose (Complete) (Air Hose)

Oto Lastik Şişirme Hortumu

Order Number
Sipariş Kodu6 mt. **DM3901-6**16 mt. **DM3901-16**9 mt. **DM3901-9**18 mt. **DM3901-18**12 mt. **DM3901-12**20 mt. **DM3901-20**13 mt. **DM3901-13**24 mt. **DM3901-24**

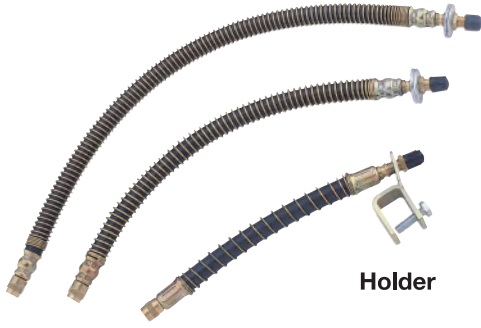
Holder
Air Hose Connection
Yaylı Tahliye Köprüsü

Order Number Sipariş Kodu	
15 cm 15 cm	25 cm 25 cm
35 cm 35 cm	

DM3902-15
DM3902-25
DM3902-35

Flexible Pipe | Akordeon Boru

Order Number Sipariş Kodu		
Ø76 Ø76	Ø90 Ø90	Ø100 Ø100

DM990126
DM990127
DM990128

Flexible Pipe | Esnek Boru

Order Number Sipariş Kodu	
Ø70-80-90-100-110-115-120-130-140-150	

DM990131

Number Plate Holder (Inox) | Plaka Tutucu

Order Number Sipariş Kodu	
2001	

2001

Gress Pump | Gress Pompası

Order Number Sipariş Kodu	
500 CCM	300 CCM

DM990129
DM990130

Emergency Hammer | Acil Yardım Çekici

Order Number Sipariş Kodu	
DM990133	

DM990133

Plastic Nut Cap | Plastik Bijon Kapağı

Order Number Sipariş Kodu	
DM990132/32	DM990132/33

DM990132/32
DM990132/33

STEERING WHEEL KNOB

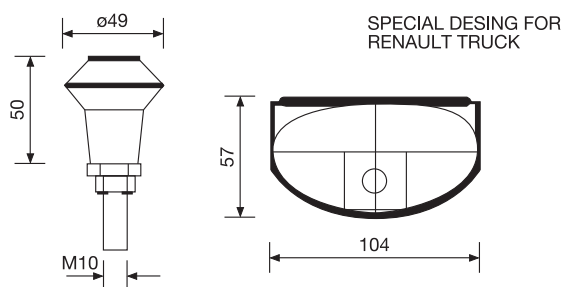
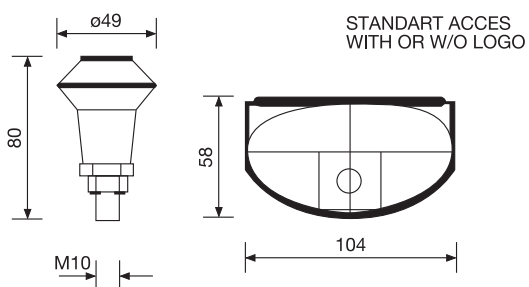

With Logo

- Mercedes **0455MER**
- Scania **0455SCA**
- Volvo **0455VOL**
- Man **0455MAN**
- Renault **0455REN**
- Iveco **0455IVE**
- Trucker **0455TRU**
- Europa **0455EUR**

W/o Logo

- 0427USTD** Chrome plated
- 0427USTDZ** Black painted

Packing

- * Single unit in a box with or w/o window
- * 12 each in a box with seperator sheet
- * 30 each in a box with seperator sheet
- * 100 unit boxes in one cartoon-box

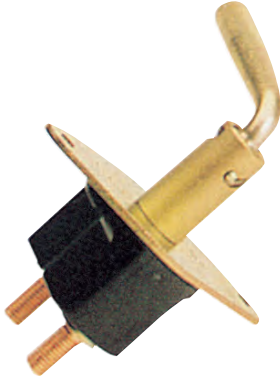

T.I.R Battery Isolator Switch (Circuit Breaker)
Tır Devre Kesici (Ağır Tip)

Order Number
Sipariş Kodu

E2323BM

Max Current: 200 Ampere



Caravan Battery Isolator Switch (Circuit Breaker) 12V
Karavan Tipi Devre Kesici

Order Number
Sipariş Kodu

E2319B

Max Current: 100 Ampere

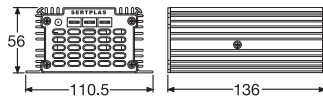

Switch Mode Converter
Konvertör

Order Number
Sipariş Kodu

K2980

24V/12V 20 Ampere
Input Voltage: 18-32V
Output Voltage: 13,3V



30 pcs Adet
27x50x27 cm
~18 kg

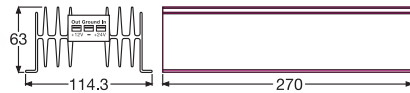

Converter
Konvertör

Order Number
Sipariş Kodu

K2979

24V/12V 20 Ampere
Power : 240W
Input voltage : 18-32V
Output voltage : 13,5V



15 pcs Adet
34x38x29 cm
~18 kg

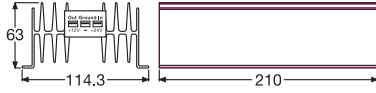

24V/12V 15 Ampere
Power : 180W
Input voltage : 18-32V
Output voltage : 13,5V



Converter
Konvertör

Order Number
Sipariş Kodu

K2978

19 pcs Adet
34x38x29 cm
~16 kg

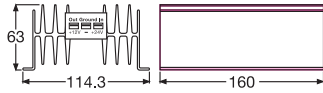

24V/12V 10 Ampere
Power : 120W
Input voltage : 18-32V
Output voltage : 13,5V



Converter
Konvertör

Order Number
Sipariş Kodu

K2977

20 pcs Adet
27x50x27 cm
~13,5 kg

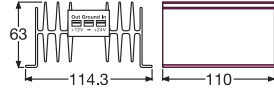
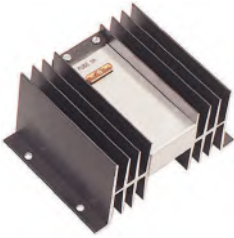

24V/12V 5 Ampere
Power : 60W
Input voltage : 18-32V
Output voltage : 13,5V



Converter
Konvertör

Order Number
Sipariş Kodu

K2976

20 pcs Adet
27x50x27 cm
~10 kg



Electronic Ballast for Fluorescent Cabin Lights (24V)
Balast Elektronik (24V)

Order Number
Sipariş Kodu



K2069

100 pcs Adet
29x40x23 cm
~20 kg

24 V. DC/08A
18 W.....40 W



Damper Lifting Switch (One Position)
Damper Kaldırma Düğmesi (Tek Pozisyonlu)

Order Number
Sipariş Kodu

IPR90019

Damper Lifting Switch
(One Position)
Damper Kaldırma Düğmesi
(Çift Pozisyonlu)



Order Number
Sipariş Kodu

IPR90018

Termal Switch Sensor (MRC Truck)
Termal Anahtar Sensörü

Order Number
Sipariş Kodu

DMIRD12074





Heavy Duty
Complete Set (5m)
Different lengths also available.



Starter Cable (Red&Black)
Akü Takviye Kablo Takımı (Kırmızı&Black)

Order Number
Sipariş Kodu

E2688EKL

5 pcs Adet
27x50,5x27 cm
~15,5 kg



Battery Clips Standard Type (Red&Black Colours)
Akü Takviye Maşası (Kırmızı&Siyah renklerde)

Order Number | Sipariş Kodu

Red | Kırmızı

Black | Siyah

E2686EYK

E2686EYZ

100 pcs Adet
45x50x25 cm
~16,05 kg



Heavy Duty



Battery Clips (Red&Black Colours)
Akü Takviye Maşası (Kırmızı&Siyah renklerde)

Order Number | Sipariş Kodu

Red | Kırmızı

Black | Siyah

E2687EYK

E2687EYZ

100 pcs Adet
45x50x25 cm
~20,98 kg

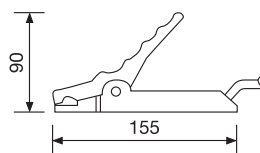

Battery Clips (for Small Vehicles) (Red&Black Colours)
Akü Takviye Maşası (Küçük Araçlar için) (Kırmızı&Siyah renklerde)

Order Number | Sipariş Kodu

Red | Kırmızı

Black | Siyah

E2420EYK

E2420EYZ

100 pcs Adet
29x40x23 cm

Starter Cable (for Small Vehicles)

Akü Takviye Kablo Takımı (Küçük Araçlar için)

Order Number
Sipariş Kodu**E2428EKL**10 pcs Adet
27x50,5x27 cm
~14,50 kg

Complete Set (2.50 m) - Double Cable

Mini Battery Clips (Red&Black Colours)

Mini Akü Takviye Masaşısı (Kırmızı&Siyah renklere)

Order Number | Sipariş Kodu

Red | Kırmızı

Black | Siyah

E2689EYK**E2689EYZ**100 pcs Adet
45x50x29 cm

New Type Single Pole Lighter Plug

Yeni Tip Tek Kutuplu Çakmak Fişi

Order Number | Sipariş Kodu

1022

Long Flasher

Uzun Flaşör

Niles Type

Order Number | Sipariş Kodu

12V

24V

K5498FR**K5588FR**

Rear Shift Horn

Geri Vites Kornası

Order Number | Sipariş Kodu

IPR07059

Toggle Switch

Geçiş Anahtarı

Merit Type

Left - Right Move

Order Number | Sipariş Kodu

E0415B



Toggle Switch
Işıklı Sinyal Anahtarı

Order Number Sipariş Kodu	
Red Light Kırmızı Işıklı	Blue Light Mavi Işıklı
DMIPR07024	DMIPR07024-2
Order Number Sipariş Kodu	
Amber Light Amber Işıklı	Green Light Yeşil Işıklı
DMIPR07024-3	DMIPR07024-4



Headlight Push-Pull Switch (with Metal Shaft)
Çiftli Çekme Anahtarı (Metal Şaftlı)

Order Number | Sipariş Kodu

E2062B



Universal Stop Switch
(305-504-505)
Fren Otomatığı

Order Number | Sipariş Kodu

IPR09018



Push Button Switch (Plastic Body)
Düğme Anahtarı (Plastik Gövde)

Order Number | Sipariş Kodu

Red | Kırmızı Blue | Mavi Black | Siyah

E8007K

E8007B

E8007S



Push - Pull Switch (with Metal Shaft)
Tekli Çekme Anahtarı (Metal Şaftlı)

Order Number | Sipariş Kodu

Short Move

Long Move

E0405B

E0406B



Stop Light Switch
Yaylı Fren Şalteri

Order Number | Sipariş Kodu

E7508B



Junction Box | Klemens Kutusu

Order Number | Sipariş Kodu

2243SSx6	6 Screw Connection / 6 Vida Bağlantılı
2243SSx8	8 Screw Connection / 8 Vida Bağlantılı
2243SSx10	10 Screw Connection / 10 Vida Bağlantılı

Right Bumper (Transit 2006-2011)

Sağ Tampon

Order Number Sipariş Kodu	
Left Sol	Right Sağ
1306L	1306R
Order Number Sipariş Kodu	
With Fog Lamp Hole Sis Far Delikli	Left Sol
1306LQ	1306RQ



Right | Sağ

Left | Sol

Grill Bumper (Transit 2006-2011)

Ön Panjur

Order Number Sipariş Kodu
1305



Front Lamp (Transit 2006-2011)

Ön Lamba

Order Number Sipariş Kodu
DM0519L



Front Signal Lamp (Transit T15) (without Socket)

Ön Sinyal Lambası (Soketsiz)

Order Number Sipariş Kodu	
Left Sol	Right Sağ
0516LL	0516LR

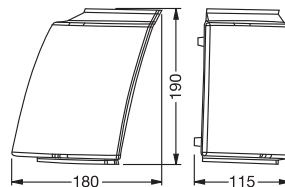

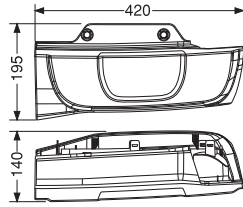

Rear Combination Lamp
(without Socket)

Arka Kombinasyon Lambası (Soketsiz)

Order Number | Sipariş Kodu

Horizontal Door
Yatay Kapı

Vertical Door
Dikey Kapı

0368LL (Left)

0368LR (Right)

0373LL (Left)

0373LR (Right)

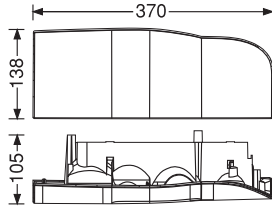
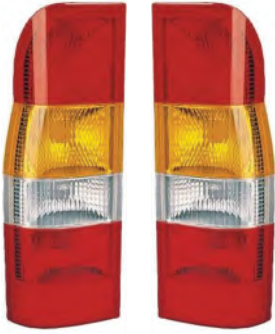

Rear Combination Lamp
(without Socket)

Arka Kombinasyon Lambası (Soketsiz)

Order Number | Sipariş Kodu

Left | Sol

Right | Sağ

0342LL

0342LR

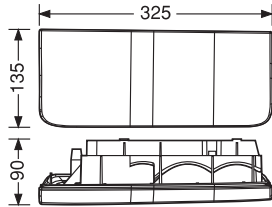
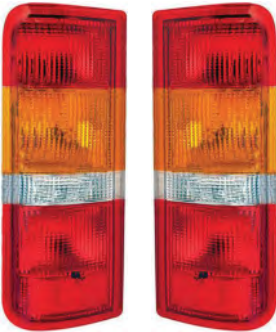

Rear Combination Lamp
(without Socket)

Arka Kombinasyon Lambası (Soketsiz)

Order Number | Sipariş Kodu

Left | Sol

Right | Sağ

0515LL

0515LR

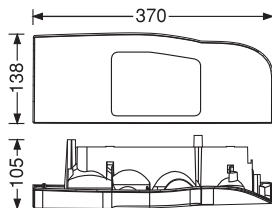

Front Signal Lamp
(without Socket)

Ön Sinyal Lambası (Soketsiz)

Order Number | Sipariş Kodu

Left | Sol

Right | Sağ

0343LL

0343LR

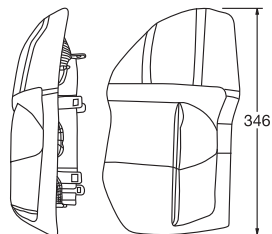

Rear Tail Lamp
(without Socket)

Arka Kuyruk Lambası (Soketsiz)

Order Number | Sipariş Kodu

Left | Sol

Right | Sağ

DM0524LL

DM0524LR

Indicator Lamp
(without Socket)

Arka Kombinasyon Lambası (Soketsiz)

Order Number Sipariş Kodu	
Left Sol	Right Sağ

0243LL

0243LR

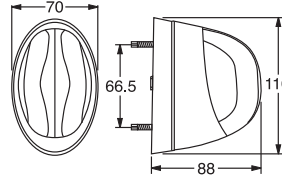

Minibus Tail Lamp

Arka Kuyruk Lambası

Order Number Sipariş Kodu	Only Lens Sadece Cam
------------------------------	-------------------------

0069LU

0069CU

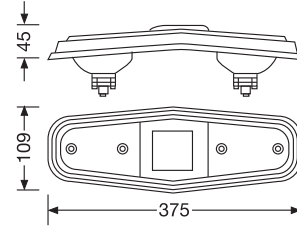

Chassis Side Mirror Blinker
(without Socket)

Kapı Aynası Sinyali (Soketsiz)

Order Number Sipariş Kodu	
Left Sol	Right Sağ

DM0348LL

DM0348LR

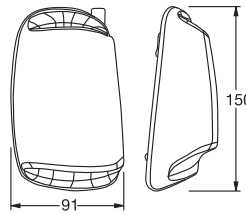

Tail Lamp (without Socket)

Kuyruk Lambası (Soketsiz)

Order Number Sipariş Kodu	
Left Sol	Right Sağ

DM0518LL

DM0518LR

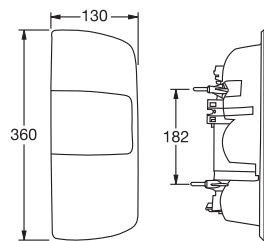

Tail Lamp (without Socket)

Kuyruk Lambası (Soketsiz)

Order Number | Sipariş Kodu

Left | Sol

Right | Sağ

DM0520LL

DM0520LR

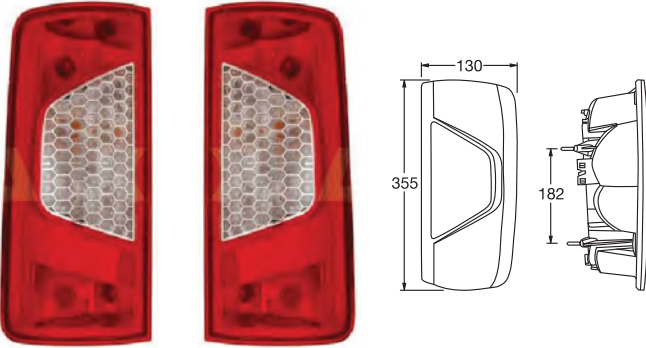

Bus Tail Lamp

Otobüs Kuyruk Lambası

Order Number | Sipariş Kodu

Left | Sol

Right | Sağ

DM0521LL

DM0521LR

Socket Code | Soket Kodu

Left | Sol

Right | Sağ

QDY54L-STŞ

QDY54R-STŞ

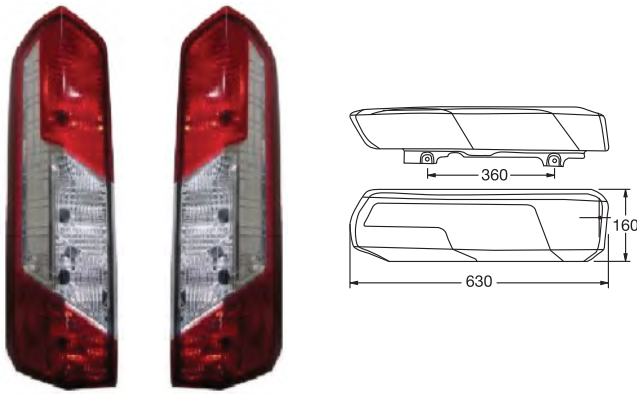

Tail Lamp

(without Socket)

Kuyruk Lambası (Soketsiz)

Order Number | Sipariş Kodu

Left | Sol

Right | Sağ

DM0523LL

DM0523LR

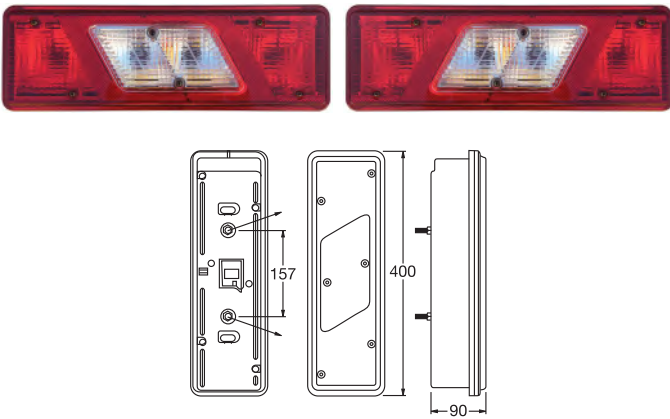

Tail Lamp (without Socket)

Kuyruk Lambası (Soketsiz)

Order Number | Sipariş Kodu

Left | Sol

Right | Sağ

5517LL

5517LR



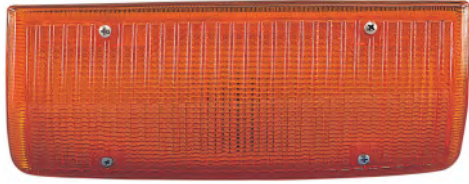

Minibus Front Signal Lamp
Minibüs Ön Sinyal Lambası



Order Number Sipariş Kodu	Only Lens Sadece Cam
------------------------------	-------------------------

0057LL (Left)
0057LR (Right)

0057CL (Left)
0057CR (Right)



Front Signal Lamp
Ön Sinyal Lambası



Order Number Sipariş Kodu	
Left Sol	Right Sağ

DM0244LL

DM0244LR

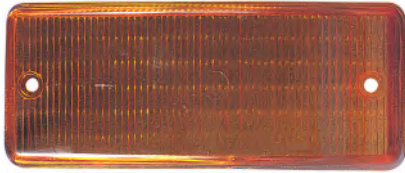

Minibus Front Signal
Minibüs Ön Sinyal



Order Number Sipariş Kodu

1142CU



Front Signal Lamp
Ön Sinyal Lambası



Order Number Sipariş Kodu	
Left Sol	Right Sağ

0136LL

0136LR



Tail Lamp
Kuyruk Lambası



Order Number Sipariş Kodu	Only Lens Sadece Cam
------------------------------	-------------------------

0096LL (Left)
0096LR (Right)

0096CL (Left)
0096CR (Right)

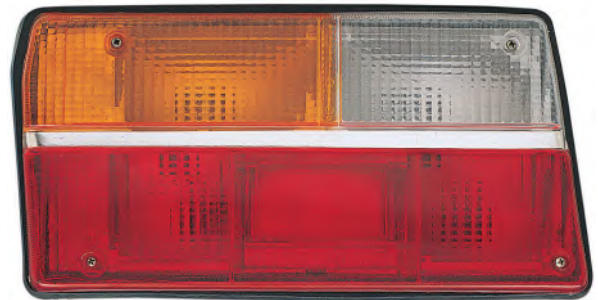

Tail Lamp
Kuyruk Lambası



Order Number Sipariş Kodu	
Left Sol	Right Sağ

0137LL

0137LR



Tail Lamp | Kuyruk Lambası

Order Number | Sipariş Kodu

 Standart Type
Standart Tip

 Written Rally GT
Rally GT Yazılı

0117LL (Left)
0117LR (Right)

0101LL (Left)
0101LR (Right)

Order Number | Sipariş Kodu

 Only Lens
Sadece Cam

 Signal Cover Lens
Sinyal Köşe Cam

1114CL (Left)
1114CR (Right)

1115CL (Left)
1115CR (Right)

Tail Lamp | Kuyruk Lambası

Order Number | Sipariş Kodu

Left | Sol

Right | Sağ

0053LL
0053LR

Only Lens | Sadece Cam

Left | Sol

Right | Sağ

0053CL
0053CR

 Tail Stop and Signal Lamp
Kuyruk Stop ve Sinyal Lambası

Order Number | Sipariş Kodu

Left | Sol

Right | Sağ

DM0245LL
DM0245LR

 Tail Lens
Kuyruk Camı

Order Number | Sipariş Kodu

Left | Sol

Right | Sağ

1208CLSK
1208CLSB

 Tail Lens
Kuyruk Camı

 Order Number
Sipariş Kodu

1207CU

 Tail Lens
Kuyruk Camı

 Order Number
Sipariş Kodu

1141CUSK

Signal Lamp
Sinyal Lambası

Order Number Sipariş Kodu	Only Lens Sadece Cam
------------------------------	-------------------------

0255LU**0255CU**

“DUR” Signboard Lamp (with 30 cm cable,
could be mounted by screw&ventouse
“DUR” Tabela Lambası (30 cm Kablolu,
vidalı kapak ile monte edilebilir.)

Order Number Sipariş Kodu

0190L

Connection Component for Signboard Lamp
(Ventouse) | Kauçuk Vantuz Kompleksi

Order Number Sipariş Kodu

5100UA

Indoor Ceiling Lamp
İç Tavan Lambası

Order Number Sipariş Kodu

0502L

Grill | Panjur

Order Number Sipariş Kodu

0841P

First Air Bag | İlk Yardım Çantası

Order Number Sipariş Kodu

5515

OE Code	Order No	Product Group	Page	OE Code	Order No	Product Group	Page	OE Code	Order No	Product Group	Page
5-5000-501	0023CL	Rear Lamp	31	1209349	0030LL72T	Rear Lamp	30	81817350	E3826FK	Plug / Socket	96
5-5400-501	0023CR	Rear Lamp	31	1357075	0030LL742	Rear Lamp	112	42013059	0029LLSK60	Rear Lamp	121
5-5100-507	0023LL50Q	Rear Lamp	33	1625985	0030LL742	Rear Lamp	112	42013058	0029LRSK60	Rear Lamp	121
5-5000-507	0023LL73Q	Rear Lamp	33	1357075	0030LL742T	Rear Lamp	29	000009939714	0153CLSK	Rear Lamp	120
5-5500-507	0023LR50Q	Rear Lamp	33	1625985	0030LL742T	Rear Lamp	29	7984796	0153CLSK	Rear Lamp	120
5-5400-507	0023LR73Q	Rear Lamp	33	1284212	0030LL75	Rear Lamp	112	7984880	0153CLSK	Rear Lamp	120
5-6000-501	0302CL	Rear Lamp	26	1304789	0030LL75	Rear Lamp	112	7984797	0153CRSB	Rear Lamp	120
5-6400-501	0302CR	Rear Lamp	26	1284212	0030LL75	Rear Lamp	112	4765757	0153LLSK71	Rear Lamp	120
5-6001-507	0302LL73	Rear Lamp	26	1304789	0030LL75	Rear Lamp	112	4808773	0153LLSK71	Rear Lamp	120
5-6011-517	0302LL73Q5	Rear Lamp	27	1209348	0030LR72	Rear Lamp	112	4765756	0153LRB71	Rear Lamp	120
5-6401-507	0302LR73	Rear Lamp	26	1284214	0030LR72	Rear Lamp	112	4808772	0153LRB71	Rear Lamp	120
5-6411-517	0302LR73Q5	Rear Lamp	27	1209348	0030LR72T	Rear Lamp	30	3567321	0205LL51	Rear Lamp	118
5-2801-707	0350LL	Rear Lamp	24	1284214	0030LR72T	Rear Lamp	30	1353205080	0368LR	Rear Lamp	168
5-3800-507	0350LL	Rear Lamp	24	1625986	0030LR742	Rear Lamp	112	1358249080	0373LL	Rear Lamp	168
5-3800-517	0350LL	Rear Lamp	24	1625986	0030LR742T	Rear Lamp	29	1358250080	0373LR	Rear Lamp	168
5-3820-517	0350LQ1L	Rear Lamp	24	1284211	0030LR75	Rear Lamp	112	42024986	0380L	Rear Lamp Round	106
5-3920-517	0350LQ1R	Rear Lamp	24	1304788	0030LR75	Rear Lamp	112	2780714	0289LUS24V	Revolving Warning	155
5-2901-707	0350LR	Rear Lamp	24	1284211	0030LR75	Rear Lamp	112	2780818	0322LUS24V	Revolving Warning	153
5-3900-507	0350LR	Rear Lamp	24	1304788	0030LR75	Rear Lamp	112	92CT2A138AA	F3820H19K16	Air Hose	100
5-3900-517	0350LR	Rear Lamp	24	086 8217	0031CU	Rear Lamp	114	92CT2A138BA	F3820H19K16	Air Hose	100
5-2800-507	0351LL73	Rear Lamp	25	152 2386	0031LL	Rear Lamp	114	81 817 350	E3826FK	Plug / Socket	96
5-2810-507	0351LL73Q1	Rear Lamp	25	152 2387	0031LR	Rear Lamp	114	81DB13A450BA	E3827FK	Plug / Socket	96
5-2900-507	0351LR73	Rear Lamp	25	0867564	0195CUKB	Rear Lamp	117	98CT14K998AA	EN3817	Plug / Socket	95
5-2910-507	0351LR73Q1	Rear Lamp	25	086 7574	0195CUSB	Rear Lamp	117	V95CT13465AA	0205LL51	Rear Lamp	118
6350JH	0368LR	Rear Lamp	168	086 7491	0195LL/RSB60	Rear Lamp	117	V95CT13464AA	0205LR51	Rear Lamp	118
6351ET	0373LL	Rear Lamp	168	086 7492	0195LL/RSB60	Rear Lamp	117	9HB15K201BA	0361LLED	Rear Lamp Round	106
6350ET	0373LR	Rear Lamp	168	090 6573	0195LL/RSB60	Rear Lamp	117	V1C4415T638AA	0322LUS24V	Revolving Warning	153
1504 961	F3822KK16	Air Couplings	102	090 6574	0195LL/RSB60	Rear Lamp	117	8C46 13B576 AA	E4215FH40	Spiral Cable	69
1504961	F3822KK16	Air Couplings	102	152 7012	0195LL/RSB60	Rear Lamp	117	8C4613B576AA	E4215FH40	Spiral Cable	69
1427 369	F3822KK22	Air Couplings	102	087 9183	0195LLSB60	Rear Lamp	117	98CT14K997AA	EN3853FU35	Spiral Cable	80
1427369	F3822KK22	Air Couplings	102	088 0195	0195RSB60	Rear Lamp	117	1485774	1305	Grill Bumper	167
0879137	F3820H19K16	Air Hose	100	1527013	0195RSB60	Rear Lamp	117	1525974	1305	Grill Bumper	167
0879138	F3820H19K16	Air Hose	100	143 5134	0205 CAM	Rear Lamp	118	1709131	1305	Grill Bumper	167
0906118	F3820H19K16	Air Hose	100	135 9954	0205LL51	Rear Lamp	118	1 102 374	0342L	Rear Lamp	168
0906120	F3820H19K16	Air Hose	100	135 9953	0205LR51	Rear Lamp	118	1 113 577	0342L	Rear Lamp	168
0906121	F3820H19K16	Air Hose	100	0698603	0221CUSB	Rear Lamp	122	1 116 630	0342L	Rear Lamp	168
1518048	F3820H19K16	Air Hose	100	0292052	0221LL/R60	Rear Lamp	122	1 205 706	0342L	Rear Lamp	168
1518049	F3820H19K16	Air Hose	100	0292224	0221LL/R60	Rear Lamp	122	4 041 627	0342L	Rear Lamp	168
087 4883	0231LL	Headlamp	137	086 7574	0284CU	Rear Lamp	116	YC15 13405 AD	0342L	Rear Lamp	168
152 4093	0231LL	Headlamp	137	0563048	0230LLED	Rear Lamp Round	106	YC15 13405 AE	0342L	Rear Lamp	168
087 4884	0231LR	Headlamp	137	563048	0230LLED	Rear Lamp Round	106	YC15 13405 AF	0342L	Rear Lamp	168
152 4094	0231LR	Headlamp	137	027 236	0361LLED	Rear Lamp Round	106	YC15 13405 AG	0342L	Rear Lamp	168
152 5311	0810231FL	Headlamp	137	656 3047	0380L	Rear Lamp Round	106	YC1X 13451 AD	0342L	Rear Lamp	168
090 7876	08120SCL	Headlamp	137	164 4058	0269LUS24V	Revolving Warning	153	1 102 373	0342R	Rear Lamp	168
090 7877	08120SCR	Headlamp	137	090 6547	0271LUS24V	Revolving Warning	153	1 113 574	0342R	Rear Lamp	168
0867930	0250LLEDZ	License Plate Light	48	161 6169	0278LUS12V	Revolving Warning	153	1 116 629	0342R	Rear Lamp	168
128 0716	0250LLEDZ	License Plate Light	48	090 6541	0315LUS24V	Revolving Warning	153	1 205 701	0342R	Rear Lamp	168
1374260	0250LLEDZ	License Plate Light	48	067 2785	0322LUS24V	Revolving Warning	153	2C14 13404 AA	0342R	Rear Lamp	168
006 7392	0084CLED	Outline Marker Light	35	083 7228	0322LUS24V	Revolving Warning	153	4 041 626	0342R	Rear Lamp	168
084 6006	0084CLED	Outline Marker Light	35	1303892	0238LUS	Side Marker Lamp	42	4 388 591	0342R	Rear Lamp	168
135 8784	0084CLED	Outline Marker Light	35	1329718	0238LUS	Side Marker Lamp	42	YC15 13404 AD	0342R	Rear Lamp	168
904 1381	0084CLED	Outline Marker Light	35	1302703	0651LUS	Side Marker Lamp	41	YC15 13404 AE	0342R	Rear Lamp	168
006 7392	0084LEMKB	Outline Marker Light	35	196 3324	0651LUS	Side Marker Lamp	41	YC15 13404 AF	0342R	Rear Lamp	168
084 6006	0084LEMKB	Outline Marker Light	35	087 1567	1651LUS	Side Marker Lamp	41	YC15 13404 AG	0342R	Rear Lamp	168
9 041 381	0084LEMKB	Outline Marker Light	35	1302707	1651LUS	Side Marker Lamp	41	YC1X 13450 AD	0342R	Rear Lamp	168
904 1381	0084LEMKB	Outline Marker Light	35	152 9468	1651LUS	Side Marker Lamp	41	1 435 881	0343L	Rear Lamp	168
135 8193	0085LEMKB	Outline Marker Light	35	1532 914	E4207FH	Spiral Cable	68	6C1113450AA	0343L	Rear Lamp	168
006 7392	0123LEMKB	Outline Marker Light	35	1602545	E4207FH	Spiral Cable	68	1 435 880	0343R	Rear Lamp	168
084 6006	0123LEMKB	Outline Marker Light	35	1645 493	E4207FH	Spiral Cable	68	6C1113451AA	0343R	Rear Lamp	168
904 1381	0123LEMKB	Outline Marker Light	35	887763	E4207FH	Spiral Cable	68	1 044 104	0515L	Rear Lamp	168
088 8980	0336LL	Outline Marker Light	34	1346 218	E4415F3M	Spiral Cable	70	1 072 424	0515L	Rear Lamp	168
090 6672	0336LL	Outline Marker Light	34	1532 917	E4415F3M	Spiral Cable	70	1 631 499	0515L	Rear Lamp	168
090 8461	0336LL	Outline Marker Light	34	1645 492	E4415F3M	Spiral Cable	70	1 641 672	0515L	Rear Lamp	168
090 6627	0336LR	Outline Marker Light	34	1346 218	E4415FH	Spiral Cable	70	1 641 703	0515L	Rear Lamp	168
090 6671	0336LR	Outline Marker Light	34	1532 917	E4415FH	Spiral Cable	70	4 505 432	0515L	Rear Lamp	168
090 8462	0336LR	Outline Marker Light	34	1645 492	E4415FH	Spiral Cable	70	6 158 264	0515L	Rear Lamp	168
090 6128	0338LL/R	Outline Marker Light	34	1346 218	E4415FH3U35	Spiral Cable	70	6 161 979	0515L	Rear Lamp	168
090 6615	0338LL/R	Outline Marker Light	34	1532 917	E4415FH3U35	Spiral Cable	70	6 188 648	0515L	Rear Lamp	168
030 4410	E2317FK	Plug / Socket	96	1645 492	E4415FH3U35	Spiral Cable	70	6 200 195	0515L	Rear Lamp	168
086 7529	E2317FK	Plug / Socket	96	0866483	EN3853F1WM40	Spiral Cable	81	6 695 706	0515L	Rear Lamp	168
030 4409	E2318FK	Plug / Socket	96	866483	EN3853F1WM40	Spiral Cable	81	7 334 714	0515L	Rear Lamp	168
086 7537	E2318FK	Plug / Socket	96	0867071	EN3853FU35	Spiral Cable	80	86VB 13405 AD1J	0515L	Rear Lamp	168
130 1760	E3826FK	Plug / Socket	96	1485535	EN3853FU35	Spiral Cable	80	86VB 13405 AE	0515L	Rear Lamp	168
130 1758	E3827FK	Plug / Socket	96	1843143	EN3853FU35	Spiral Cable	80	86VB 13405 AF	0515L	Rear Lamp	168
1374451	E3827FK	Plug / Socket	96	867071	EN3853FU35	Spiral Cable	80	86VB 13405 AG	0515L	Rear Lamp	168
1506 027	E4707FQ1	Plug / Socket	94	0866484	ES3853FU35	Spiral Cable	80	86VB 13405 AH	0515L	Rear Lamp	168
1506027	E4707FQ1	Plug / Socket	94	1367149	ES3853FU35	Spiral Cable	80	90VB 13405 AA	0515L	Rear Lamp	168
1609477	E4707FQ1	Plug / Socket	94	1485 545	ES3853FU35	Spiral Cable	80	90VB 13405 AB	0515L	Rear Lamp	168
0703748	EN3815	Plug / Socket	95	1627155	ES3853FU35	Spiral Cable	80	95VG 13405 AA	0515L	Rear Lamp	168
152 7114	EN3815	Plug / Socket	95	1645496	ES3853FU35	Spiral Cable	80	95VG 13405 AB	0515L	Rear Lamp	168
703748	EN3815	Plug / Socket	95	1840559	ES3853FU35	Spiral Cable	80	95VG 13405 AC	0515L	Rear Lamp	168
1383002	EN3816	Plug / Socket	95	866484	ES3853FU35	Spiral Cable	80	95VG 13405 AD	0515L	Rear Lamp	168
130 1750	EN3817	Plug / Socket	95	000 820 90 56	0250LLEDZ	License Plate Light	48	95VG 13405 AF	0515L	Rear Lamp	168
152 3985	EN4817	Plug / Socket	95	3530000001	0250LLEDZ	License Plate Light	48	D86VB 13405 AF	0515L	Rear Lamp	168
1384309	ES3816	Plug / Socket	95	7 544 119 000 0	0250LLEDZ	License Plate Light	48	1 044 103	0515R	Rear Lamp	168
1301755	ES4817	Plug / Socket	95	011 545 26 26	E2318FK	Plug / Socket	96	1 072 423	0515R	Rear Lamp	168
086 7491	00284LU	Rear Lamp	116	370 545 00 28	E4015FQ1	Plug / Socket	94	1 631 498	0515R	Rear Lamp	168
152 7012	00284LU	Rear Lamp	116	006 545 06 26	EN3817						

OE Code	Order No	Product Group	Page	OE Code	Order No	Product Group	Page	OE Code	Order No	Product Group	Page
86VB 13404 AG	0515R	Rear Lamp	168	0000007984015	0153CRSB	Rear Lamp	120	81963410012	F3820H19K16	Air Hose	100
86VB 13404 AH	0515R	Rear Lamp	168	7981048	0153CRSB	Rear Lamp	120	82963400511	F3820H19K16	Air Hose	100
90VB 13404 AA	0515R	Rear Lamp	168	7984015	0153CRSB	Rear Lamp	120	28.12526.0605.61	0084CLED	Outline Marker Light	35
90VB 13404 AB	0515R	Rear Lamp	168	93158530	0153CRSB	Rear Lamp	120	81.25229.0562	0084CLED	Outline Marker Light	35
95VG 13404 AA	0515R	Rear Lamp	168	93158536	0153CRSB	Rear Lamp	120	81.25260.6056	0084CLED	Outline Marker Light	35
95VG 13404 AB	0515R	Rear Lamp	168	9939713	0153CRSB	Rear Lamp	120	28.12526.0605.61	0084LEMKB	Outline Marker Light	35
95VG 13404 AC	0515R	Rear Lamp	168	0000001904640	0153LLSK71	Rear Lamp	120	81.25260.6056	0084LEMKB	Outline Marker Light	35
95VG 13404 AD	0515R	Rear Lamp	168	1904640	0153LLSK71	Rear Lamp	120	28.12526.0605.61	0123LEMKB	Outline Marker Light	35
D86VB 13404 AF	0515R	Rear Lamp	168	1907701	0153LLSK71	Rear Lamp	120	81.25260.6056	0123LEMKB	Outline Marker Light	35
4974083	DM0520LL	Rear Lamp	170	4769138	0153LLSK71	Rear Lamp	120	81.25435.0175	E2317FK	Plug / Socket	96
5098938	DM0520LL	Rear Lamp	170	4808775	0153LLSK71	Rear Lamp	120	81.25432.6042	E2617	Plug / Socket	94
5103002	DM0520LL	Rear Lamp	170	4810329	0153LLSK71	Rear Lamp	120	81.25435.0086	EN3815	Plug / Socket	95
5177813	DM0520LL	Rear Lamp	170	7567811	0153LLSK71	Rear Lamp	120	81.25435.0199	EN3815	Plug / Socket	95
4974082	DM0520LR	Rear Lamp	170	1904639	0153RSB71	Rear Lamp	120	33.25432.6019	EN3817	Plug / Socket	95
5098937	DM0520LR	Rear Lamp	170	1907700	0153RSB71	Rear Lamp	120	81.25225.6403	00211L	Rear Lamp	122
5103001	DM0520LR	Rear Lamp	170	4808774	0153RSB71	Rear Lamp	120	81.25225.6403	00211R	Rear Lamp	122
5177810	DM0520LR	Rear Lamp	170	4810327	0153RSB71	Rear Lamp	120	28.12522.9085.9	0029CUSK	Rear Lamp	121
1815610	DM0521LL	Rear Lamp	170	7567810	0153RSB71	Rear Lamp	120	81.25229.0859	0029CUSK	Rear Lamp	121
1822207	DM0521LL	Rear Lamp	170	4246.0353	0205 CAM	Rear Lamp	118	85.20001-2512	0029RSK60	Rear Lamp	121
1829126	DM0521LL	Rear Lamp	170	41993810EZ6727-	0205LL60	Rear Lamp	118	81.25229-6051	0030CU	Rear Lamp	112
1846554	DM0521LL	Rear Lamp	170	42013219K25026-	0205LL60	Rear Lamp	118	81.25229-6052	0030CU	Rear Lamp	112
1848243	DM0521LL	Rear Lamp	170	42555131	0294CUB	Rear Lamp	119	81.25225-6442	0030L72	Rear Lamp	112
1855335	DM0521LL	Rear Lamp	170	42555132	0294CUB	Rear Lamp	119	81.25225-6465	0030L72	Rear Lamp	112
1870426	DM0521LL	Rear Lamp	170	5801351218	0294LLBB74	Rear Lamp	119	81.25225-6975	0030L72	Rear Lamp	112
1815607	DM0521LR	Rear Lamp	170	5801631438	0294LLBB74	Rear Lamp	119	81.25228-6024	0030L72	Rear Lamp	112
1822206	DM0521LR	Rear Lamp	170	69500032	0294LLBB74	Rear Lamp	119	81.25228-6025	0030L72	Rear Lamp	112
1829125	DM0521LR	Rear Lamp	170	5801351224	0294LLBB74	Rear Lamp	119	81.25228-6029	0030L72	Rear Lamp	112
1846553	DM0521LR	Rear Lamp	170	5801631433	0294LLBB74	Rear Lamp	119	81.25228-6034	0030L72	Rear Lamp	112
1848242	DM0521LR	Rear Lamp	170	69500026	0294LLBB74	Rear Lamp	119	81.25228-6036	0030L72	Rear Lamp	112
1855334	DM0521LR	Rear Lamp	170	248.1978KZ5026-	0361LLED	Rear Lamp Round	106	81252286035	0030L72	Rear Lamp	112
1870425	DM0521LR	Rear Lamp	170	2481.978	0361LLED	Rear Lamp Round	106	81.25225-6442	0030L72T	Rear Lamp	30
1370942	1306L	Side Bumper	167	4162.2525	0363LLED	Rear Lamp Round	106	81.25225-6465	0030L72T	Rear Lamp	30
1387149	1306L	Side Bumper	167	4162.2525EE6927-	0363LLED	Rear Lamp Round	106	81.25225-6975	0030L72T	Rear Lamp	30
1437326	1306L	Side Bumper	167	4163.2525	0363LLED	Rear Lamp Round	106	81.25228-6024	0030L72T	Rear Lamp	30
1370881	1306LQ	Side Bumper	167	5032.90661	0363LLED	Rear Lamp Round	106	81.25228-6025	0030L72T	Rear Lamp	30
1387148	1306LQ	Side Bumper	167	4120.0255	0380L	Rear Lamp Round	106	81.25228-6029	0030L72T	Rear Lamp	30
1437092	1306LQ	Side Bumper	167	4202.4986	0380L	Rear Lamp Round	106	81.25228-6034	0030L72T	Rear Lamp	30
1370942	1306R	Side Bumper	167	5002.54098	0209LUS24V	Revolving Warning	153	81.25228-6036	0030L72T	Rear Lamp	30
1387149	1306R	Side Bumper	167	2780.714	0289LUS24V	Revolving Warning	155	81252286035	0030L72T	Rear Lamp	30
1437326	1306R	Side Bumper	167	0278.0823KZ6700-	0322LUS24V	Revolving Warning	153	81.25225-6519	0030L742	Rear Lamp	112
1370880	1306RQ	Side Bumper	167	2780.818	0322LUS24V	Revolving Warning	153	81.25225-6524	0030L742	Rear Lamp	112
1387147	1306RQ	Side Bumper	167	0000500308514	0238LUS	Side Marker Lamp	42	81.25225-6526	0030L742	Rear Lamp	112
1437091	1306RQ	Side Bumper	167	500308514	0238LUS	Side Marker Lamp	42	81252256465	0030L742	Rear Lamp	112
2069626	DM00524LL	Rear Lamp	168	5.0003.7411	EN3853FU35	Spiral Cable	80	81252286034	0030L742	Rear Lamp	112
ET7613404AB	DM00524LL	Rear Lamp	168	5.0003.7413	EN3853FU35	Spiral Cable	80	81.25225-6519	0030L742T	Rear Lamp	29
2069551	DM0524LR	Rear Lamp	168	500037411	EN3853FU35	Spiral Cable	80	81.25225-6524	0030L742T	Rear Lamp	29
ET7613405AB	DM0524LR	Rear Lamp	168	500037413	EN3853FU35	Spiral Cable	80	81.25225-6526	0030L742T	Rear Lamp	29
2515298	F3822KK16	Air Couplings	102	5.0003.7412	ES3853FU35	Spiral Cable	80	81.25225-6526	0030L742T	Rear Lamp	29
2515436	F3822KK16	Air Couplings	102	5.0003.7414	ES3853FU35	Spiral Cable	80	81252256465	0030L742T	Rear Lamp	29
2516898	F3822KK16	Air Couplings	102	500037412	ES3853FU35	Spiral Cable	80	81252286034	0030L742T	Rear Lamp	29
2521369	F3822KK16	Air Couplings	102	500037414	ES3853FU35	Spiral Cable	80	81252286036	0030L742T	Rear Lamp	29
42070652	F3822KK16	Air Couplings	102	81.51220.6010	F3822KK16	Air Couplings	102	81.25225-6033	0030L72	Rear Lamp	112
42088851	F3822KK16	Air Couplings	102	81.51220.6012	F3822KK16	Air Couplings	102	81.25228-6024	0030L72	Rear Lamp	112
4841036	F3822KK16	Air Couplings	102	81.51220.6026	F3822KK16	Air Couplings	102	81.25228-6030	0030L72	Rear Lamp	112
4680365	F3822KK22	Air Couplings	102	81.51220.6031	F3822KK16	Air Couplings	102	81.25228-6035	0030L72	Rear Lamp	112
61577724	F3822KK22	Air Couplings	102	81.51220.6045	F3822KK16	Air Couplings	102	81252286033	0030L72	Rear Lamp	112
0000041822954	0250LLEDZ	License Plate Light	48	81.51220.6068	F3822KK16	Air Couplings	102	81.25225-6033	0030L72T	Rear Lamp	30
4162.3679	0250LLEDZ	License Plate Light	48	81.51220.6078	F3822KK16	Air Couplings	102	81.25228-6024	0030L72T	Rear Lamp	30
4182.2954	0250LLEDZ	License Plate Light	48	81.51220.6094	F3822KK16	Air Couplings	102	81.25228-6030	0030L72T	Rear Lamp	30
9944.6126	0084CLED	Outline Marker Light	35	81.51220.6095	F3822KK16	Air Couplings	102	81.25228-6035	0030L72T	Rear Lamp	30
9944.6126	0084LEMKB	Outline Marker Light	35	81.51220.6097	F3822KK16	Air Couplings	102	81252286033	0030L72T	Rear Lamp	30
9944.6126	0123LEMKB	Outline Marker Light	35	81.51220.6102	F3822KK16	Air Couplings	102	81.25225-6518	0030L742	Rear Lamp	112
042080026	E2617	Plug / Socket	94	81.51220.6110	F3822KK16	Air Couplings	102	81.25225-6523	0030L742	Rear Lamp	112
4208.0026	E2617	Plug / Socket	94	81.51220.6111	F3822KK16	Air Couplings	102	81.25225-6525	0030L742	Rear Lamp	112
5.0353.2783	E2617	Plug / Socket	94	81.51220.6010	F3822KK16	Air Couplings	102	81.25225-6529	0030L742	Rear Lamp	112
5.0357.9488	E2617	Plug / Socket	94	81.51220.6012	F3822KK16	Air Couplings	102	81.25225-6530	0030L742	Rear Lamp	112
9849.1404	E2617	Plug / Socket	94	81.51220.6026	F3822KK16	Air Couplings	102	81.25225-6518	0030L742T	Rear Lamp	29
4248.9073	E3827FK	Plug / Socket	96	81.51220.6031	F3822KK16	Air Couplings	102	81.25225-6523	0030L742T	Rear Lamp	29
7826.92	EN3815	Plug / Socket	95	81.51220.6045	F3822KK16	Air Couplings	102	81.25225-6525	0030L742T	Rear Lamp	29
9944.6124	0021LL	Rear Lamp	122	81.51220.6068	F3822KK16	Air Couplings	102	81.25225-6529	0030L742T	Rear Lamp	29
9944.6124	0021LR	Rear Lamp	122	81.51220.6078	F3822KK16	Air Couplings	102	81.25225-6530	0030L742T	Rear Lamp	29
4162.8725	0029LLSK60	Rear Lamp	121	81.51220.6094	F3822KK16	Air Couplings	102	81.25229.6033	0205 CAM	Rear Lamp	118
4201.3059	0029LLSK60	Rear Lamp	121	81.51220.6095	F3822KK16	Air Couplings	102	81.25229.6036	0205 CAM	Rear Lamp	118
4162.8726	0029RLSK60	Rear Lamp	121	81.51220.6097	F3822KK16	Air Couplings	102	81.25229.6033	0205 CAM	Rear Lamp	118
4201.3058	0029RLSK60	Rear Lamp	121	81.51220.6102	F3822KK16	Air Couplings	102	81.25228-6011	0205LL60	Rear Lamp	118
93161844	0030CU	Rear Lamp	112	81.51220.6110	F3822KK16	Air Couplings	102	81.25229-6040	0205LL60	Rear Lamp	118
0000099463248	0030LL71	Rear Lamp	112	81.51220.6111	F3822KK16	Air Couplings	102	81.25285-6151	0205LL60	Rear Lamp	118
37109000	0030LL71	Rear Lamp	112	81.512206010	F3822KK16	Air Couplings	102	81.25225-6399	0205LL72	Rear Lamp	118
99461939	0030LL71	Rear Lamp	112	81512206012	F3822KK16	Air Couplings	102	81.25228-6011	0205LL72	Rear Lamp	118
99463243	0030LL71	Rear Lamp	112	81512206026	F3822KK16	Air Couplings	102	81.25225-6531	0205LL74	Rear Lamp	118
99463244	0030LL71	Rear Lamp	112	81512206031	F3822KK16	Air Couplings	102	85.20001-1848	0205LR51	Rear Lamp	118
99463248	0030LL71	Rear Lamp	112	81512206045	F3822KK16	Air Couplings	102	81.25229.6037	0205LR60	Rear Lamp	118
99491940	0030LL71	Rear Lamp	112	81512206068	F3822KK16	Air Couplings	102	81.25225-6030	0205LR60	Rear Lamp	

OE Code	Order No	Product Group	Page	OE Code	Order No	Product Group	Page	OE Code	Order No	Product Group	Page
81.25207.6038	0322LUS24V	Revolving Warning	153	A 000 820 37 58	0289LUS24V	Revolving Warning	155	1 467 003	0810FR	Headlamp	137
81.25225.6499	0268LUS	Side Marker Lamp	44	A 000 820 73 58	0322LUS12V	Revolving Warning	153	1 732 510	0810FR	Headlamp	137
81.25225-6499	0268LUS	Side Marker Lamp	44	A 000 820 57 58	0322LUS24V	Revolving Warning	153	1 446 583	08120SCL	Headlamp	137
81.25225-6502	0268LUS	Side Marker Lamp	44	A 000 820 74 58	0322LUS24V	Revolving Warning	153	1 446 584	08120SCL	Headlamp	137
81.25260.6079	0268LUS	Side Marker Lamp	44	A 000 540 80 39	E4207FH40	Spiral Cable	68	134 9779	08120SCL	Headlamp	137
81.25260.6088	0268LUS	Side Marker Lamp	44	9501003185	E4215FH40	Spiral Cable	69	134 9780	08120SCR	Headlamp	137
81.25260.6089	0268LUS	Side Marker Lamp	44	A 000 540 79 39	E4215FH40	Spiral Cable	69	1 732 515	QKT29	Headlamp	137
81.25260.6091	0268LUS	Side Marker Lamp	44	B67530155	E4415F3M	Spiral Cable	70	146 7007	QKT29	Headlamp	137
81.25260.6105	0268LUS	Side Marker Lamp	44	A 000 545 67 84	E4415FH0P40	Spiral Cable	70	1 379 384	0250LLEDZ	License Plate Light	48
81.25260-6079	0268LUS	Side Marker Lamp	44	B67530155	E4415FH	Spiral Cable	70	2 127 835	0250LLEDZ	License Plate Light	48
81.25260-6081	0268LUS	Side Marker Lamp	44	B67530155	E4415FH3U35	Spiral Cable	70	419 888	0250LLEDZ	License Plate Light	48
81.25260-6088	0268LUS	Side Marker Lamp	44	4.10119	EN3853F1WM40	Spiral Cable	81	2 022 831	0084CLED	Outline Marker Light	35
81.25260-6089	0268LUS	Side Marker Lamp	44	410119	EN3853F1WM40	Spiral Cable	81	2 022 908	0084CLED	Outline Marker Light	35
81.25260-6105	0268LUS	Side Marker Lamp	44	387 540 0139	EN3853FU35	Spiral Cable	80	2 022 831	0084LEMKB	Outline Marker Light	35
81252256499	0268LUS	Side Marker Lamp	44	3875400139	EN3853FU35	Spiral Cable	80	2 022 832	0085LEMKB	Outline Marker Light	35
81252606079	0268LUS	Side Marker Lamp	44	A 387 540 0239	EN3853FU35	Spiral Cable	80	2 022 831	0123LEMKB	Outline Marker Light	35
81252606088	0268LUS	Side Marker Lamp	44	673 540 0139	ES3853FU35	Spiral Cable	80	2 022 578	E2317FK	Plug / Socket	96
81252606089	0268LUS	Side Marker Lamp	44	6735400139	ES3853FU35	Spiral Cable	80	199 408	E2318FK	Plug / Socket	96
81252606091	0268LUS	Side Marker Lamp	44	A 000 544 21 04	0396LUK	Rear Lamp	104	1360800	E2617	Plug / Socket	94
81252606105	0268LUS	Side Marker Lamp	44	A 000 826 19 44	0394LUB	Rear Lamp	104	1928565	E2617	Plug / Socket	94
85.20001-3227	0268LUS	Side Marker Lamp	44	A 000 826 18 44	0392LUB	Rear Lamp	104	2 022 3452	E2617	Plug / Socket	94
81.25411.6017	E4207FH	Spiral Cable	68	A 000 826 11 43	0391LUS	Rear Lamp	104	332764	E2617	Plug / Socket	94
81.25411.6033	E4207FH	Spiral Cable	68	A 000 826 04 51	5517LL	Rear Lamp	170	1316850	E3827FK	Plug / Socket	96
81.25411.6034	E4207FH	Spiral Cable	68	A 906 820 01 64	5517LL	Rear Lamp	170	0 179 530	EN3815	Plug / Socket	95
81.25411.6043	E4207FH	Spiral Cable	68	A 000 826 05 51	5517LR	Rear Lamp	170	179 530	EN3815	Plug / Socket	95
81.25411.6047	E4207FH	Spiral Cable	68	A 906 820 02 64	5517LR	Rear Lamp	170	2 022 816	EN3815	Plug / Socket	95
81.25411.6058	E4207FH	Spiral Cable	68	45 30 064 863	0084CLED	Outline Marker Light	35	1403837	EN3816	Plug / Socket	95
82.25449.0004	E4207FH	Spiral Cable	68	54 30 064 863	0084CLED	Outline Marker Light	35	2037735	EN3816	Plug / Socket	95
81.25411.6038	EN3853FU35	Spiral Cable	80	45 30 064 863	0084LEMKB	Outline Marker Light	35	0 179 529	EN3817	Plug / Socket	95
81.25411.6050	EN3853FU35	Spiral Cable	80	54 30 064 863	0084LEMKB	Outline Marker Light	35	179 529	EN3817	Plug / Socket	95
81.25411.6051	ES3853FU35	Spiral Cable	80	45 30 064 863	0123LEMKB	Outline Marker Light	35	2 022 817	EN3817	Plug / Socket	95
A 000 429 39 30	F3822KK16	Air Couplings	102	54 30 064 863	0123LEMKB	Outline Marker Light	35	1403838	ES3816	Plug / Socket	95
A 000 429 55 30	F3822KK16	Air Couplings	102	5000 442 713	F3822KK16	Air Couplings	102	2037736	ES3816	Plug / Socket	95
A 000 429 58 30	F3822KK16	Air Couplings	102	5000442713	F3822KK16	Air Couplings	102	241 227	0021LL	Rear Lamp	122
A 000 429 61 30	F3822KK16	Air Couplings	102	5000440154	F3822KK22	Air Couplings	102	241 227	0021LR	Rear Lamp	122
A 000 429 80 30	F3822KK16	Air Couplings	102	50 10 293 829	0250LLEDZ	License Plate Light	48	2 022 974	0029LRSK60	Rear Lamp	121
A 000 429 86 30	F3822KK16	Air Couplings	102	5430 064 863	0084LEMKB	Outline Marker Light	35	1 380 819	0030CU	Rear Lamp	112
A 000 429 96 30	F3822KK16	Air Couplings	102	50 00 790 957	E2617	Plug / Socket	94	1380819	0030CU	Rear Lamp	112
A 000 429 35 30	F3822KK22	Air Couplings	102	5000790957	E2617	Plug / Socket	94	1350339	0030LL60	Rear Lamp	113
A 940 820 01 61	0369L	Headlamp	138	5010 589 539	E2617	Plug / Socket	94	1365963	0030LL60	Rear Lamp	113
A 940 820 02 61	0369R	Headlamp	138	5010589539	E2617	Plug / Socket	94	1365965	0030LL60	Rear Lamp	113
A 000 826 42 10	0369SCL	Headlamp	138	50 10 589 541	E4707FQ1	Plug / Socket	94	1350339	0030LL61T	Rear Lamp	30
A 000 826 43 10	0369SCR	Headlamp	138	50 10 589 542	E4707FQ1	Plug / Socket	94	1365963	0030LL61T	Rear Lamp	30
A 000 820 90 56	0250LLEDZ	License Plate Light	48	5010589541	E4707FQ1	Plug / Socket	94	1365965	0030LL61T	Rear Lamp	30
A 001 820 76 56	0250LLEDZ	License Plate Light	48	5010589542	E4707FQ1	Plug / Socket	94	1350340	0030LR60	Rear Lamp	113
A 000 826 05 16	0084CLED	Outline Marker Light	35	74 85 113 791	E4707FQ1	Plug / Socket	94	1365964	0030LR60	Rear Lamp	113
A 699 544 01 10	0084CLED	Outline Marker Light	35	74 85 113 793	E4707FQ1	Plug / Socket	94	1350340	0030LR61T	Rear Lamp	30
A 939 723 10 93 01	0084CLED	Outline Marker Light	35	74 85 115 564	E4707FQ1	Plug / Socket	94	1365964	0030LR61T	Rear Lamp	30
A 699 544 01 10	0084LEMKB	Outline Marker Light	35	7485113791	E4707FQ1	Plug / Socket	94	2 022 754	0205 CAM	Rear Lamp	118
A 939 723 10 93 01	0084LEMKB	Outline Marker Light	35	7485113793	E4707FQ1	Plug / Socket	94	2 022 856	0205LL51	Rear Lamp	118
A 699 544 01 10	0123LEMKB	Outline Marker Light	35	7485115564	E4707FQ1	Plug / Socket	94	2 022 797	0205LR51	Rear Lamp	118
A 939 723 10 93 01	0123LEMKB	Outline Marker Light	35	50 00 296 594	0030CU	Rear Lamp	112	1784669	0360CLBB	Rear Lamp	109
A 011 545 26 26	E2318FK	Plug / Socket	96	50 01 847 588	0030CU	Rear Lamp	112	1756754	0360LLBB742	Rear Lamp	109
A 004 545 32 26	E3827FK	Plug / Socket	96	50 01 847 584	0030LL742	Rear Lamp	112	1906552	0360LLBB742	Rear Lamp	109
A004 545 21 28	EN3815	Plug / Socket	95	50 01 847 586	0030LL742	Rear Lamp	112	2021579	0360LLBB742	Rear Lamp	109
A 001 545 06 26	EN3817	Plug / Socket	95	50 01 847 584	0030LL742T	Rear Lamp	29	2129985	0360LLBB742	Rear Lamp	109
A 003 545 31 26	EN3817	Plug / Socket	95	50 01 847 586	0030LL742T	Rear Lamp	29	1756751	0360LRBB742	Rear Lamp	109
A 006 545 06 26	EN3817	Plug / Socket	95	50 01 847 585	0030LR742	Rear Lamp	112	1791369	0360LRBB742	Rear Lamp	109
A 001 544 83 90	0029CUSK	Rear Lamp	121	50 01 847 585	0030LR742T	Rear Lamp	29	1906549	0360LRBB742	Rear Lamp	109
A 001 544 68 03	0029LRSK60	Rear Lamp	121	50 00 808 166	0221CUSB	Rear Lamp	122	1906551	0360LRBB742	Rear Lamp	109
A 001 544 81 03	0029LLSK60	Rear Lamp	121	50 00 808 172	0221LL/R60	Rear Lamp	122	2021575	0360LRBB742	Rear Lamp	109
A 001 544 82 03	0029LLSK60	Rear Lamp	121	50 10 231 957	0238LUS	Side Marker Lamp	42	2021577	0360LRBB742	Rear Lamp	109
A 001 544 85 03	0029LLSK60	Rear Lamp	121	50 10 306 792	0238LUS	Side Marker Lamp	42	2129987	0360LRBB742	Rear Lamp	109
A 002 544 58 03	0029LLSK60	Rear Lamp	121	50 01 832 940	0651LUS	Side Marker Lamp	41	2129989	0360LRBB742	Rear Lamp	109
A 001 544 68 03	0029LRSK60	Rear Lamp	121	50 01 832 941	0651LUS	Side Marker Lamp	41	20 223 791	0361LLED	Rear Lamp Round	106
A 001 544 81 03	0029LRSK60	Rear Lamp	121	50 10 306 930	E4215FH40	Spiral Cable	69	20 223 918	0209LUS24V	Revolving Warning	153
A 001 544 85 03	0029LRSK60	Rear Lamp	121	5010306930	E4215FH40	Spiral Cable	69	2 022 926	1651LUS	Side Marker Lamp	41
A 002 544 58 03	0029LRSK60	Rear Lamp	121	5010542755	E4215FH40	Spiral Cable	69	1357170	EN3853FU35	Spiral Cable	80
A 002 544 47 90	0031CU	Rear Lamp	114	5010589453	E4215FH40	Spiral Cable	69	1399745	EN3853FU35	Spiral Cable	80
A 002 544 98 03	0031LL	Rear Lamp	114	7421680280	E4215FH40	Spiral Cable	69	1771343	EN3853FU35	Spiral Cable	80
A 003 544 56 03	0031LL	Rear Lamp	114	50 10 392 008	EN3853FU35	Spiral Cable	80	1771443	EN3853FU35	Spiral Cable	80
A 003 544 59 03	0031LL	Rear Lamp	114	5010392008	EN3853FU35	Spiral Cable	80	1864192	EN3853FU35	Spiral Cable	80
A 002 544 97 03	0031LR	Rear Lamp	114	50 10 392 009	ES3853FU35	Spiral Cable	80	1904336	EN3853FU35	Spiral Cable	80
A 003 544 55 03	0031LR	Rear Lamp	114	5010392009	ES3853FU35	Spiral Cable	80	1947587	EN3853FU35	Spiral Cable	80
A 003 544 57 03	0031LR	Rear Lamp	114	318 158	F3822KK16	Air Couplings	102	1947589	ES3853FU35	Spiral Cable	80
A 002 544 06 90	0195CUKB	Rear Lamp	117	318158	F3822KK16	Air Couplings	102	050116	F3820H19K16	Air Hose	100
A 002 544 06 90 64	0195CUKB	Rear Lamp	117	1934822	F3820H19K16	Air Hose	100	050117	F3820H19K16	Air Hose	100
A 002 544 09 03	0195LSB60	Rear Lamp	117	1934823	F3820H19K16	Air Hose	100	1093511	F3820H19K16	Air Hose	100
A 002 544 07 03	0195LRSB60	Rear Lamp	117	20188945	F3820H19K16	Air Hose	100	1093512	F3820H19K16	Air Hose	100
A 001 540 58 70	0195LRSB60	Rear Lamp	117	2090338	F3820H19K16	Air Hose	100	50116	F3820H19K16	Air Hose	100
A 001 540 63 70	0195LRSB60	Rear Lamp	117	1 385 410	0231LL	Headlamp	137	50117	F3820H19K16	Air Hose	100
A 699 544 03 03	0205LL51	Rear Lamp	118	1 387 155	0231LR	Headlamp	137	S050116	F3820H19K16	Air Hose	100
A 716 285 02 30	0205LL51										

OE Code	Order No	Product Group	Page	OE Code	Order No	Product Group	Page
740305	0123LEMKB	Outline Marker Light	35	8209849	0801YR01T	Headlamp	125
1133925	0336LL	Outline Marker Light	34	8220 9849	0801YR01T	Headlamp	125
1133926	0336LR	Outline Marker Light	34	82209849	0801YR01T	Headlamp	125
060110	E2317FK	Plug / Socket	96	8236 7957	0801YR01T	Headlamp	125
060117	E2317FK	Plug / Socket	96	82367957	0801YR01T	Headlamp	125
060140	E2318FK	Plug / Socket	96	1 114 775 6	0250LLEDZ	License Plate Light	48
080140	E2318FK	Plug / Socket	96	20721495	0250LLEDZ	License Plate Light	48
054 506	E2617	Plug / Socket	94	4 374 231	0250LLEDZ	License Plate Light	48
060108	EN3815	Plug / Socket	95	VOE11147756	0250LLEDZ	License Plate Light	48
1023102	EN3815	Plug / Socket	95	351 294	E2317FK	Plug / Socket	96
1-FZELEK0028	EN3815	Plug / Socket	95	795 720	E2317FK	Plug / Socket	96
2929	EN3815	Plug / Socket	95	11 305 874	E2318FK	Plug / Socket	96
7189	EN3815	Plug / Socket	95	7 049 710	E2318FK	Plug / Socket	96
064710	EN3816	Plug / Socket	95	795 719	E2318FK	Plug / Socket	96
060138	EN3817	Plug / Socket	95	1609076	E2617	Plug / Socket	94
528651	EN3817	Plug / Socket	95	8158175	E2617	Plug / Socket	94
064711	ES3816	Plug / Socket	95	2 052 079	E3827FK	Plug / Socket	96
060515	0021LL	Rear Lamp	122	2 052 079 4	E3827FK	Plug / Socket	96
060515	0021LR	Rear Lamp	122	8 180 080 01	E3827FK	Plug / Socket	96
000-40.073	00284LU	Rear Lamp	116	1077502	EN3816	Plug / Socket	95
062774	00284LU	Rear Lamp	116	85103345	EN3816	Plug / Socket	95
000-40.070	00284LU51	Rear Lamp	116	2 126 499 5	EN3817	Plug / Socket	95
000-40.061	00284LU79	Rear Lamp	116	3 171 182	EN3817	Plug / Socket	95
063392	00284LU79	Rear Lamp	116	1077503	ES3816	Plug / Socket	95
ELO007-0004	00284LU79	Rear Lamp	116	85103347	ES3816	Plug / Socket	95
060526	0029CUSK	Rear Lamp	121	348 750	0021LL	Rear Lamp	122
060552	0029LLSK60	Rear Lamp	121	348 750	0021LR	Rear Lamp	122
060565	0029LLSK60	Rear Lamp	121	3981782	0030CU	Rear Lamp	112
1-FZELEK0498	0029LLSK60	Rear Lamp	121	8142919	0030CU	Rear Lamp	112
060553	0029LRSK60	Rear Lamp	121	4803218	0230LLED	Rear Lamp Round	106
060566	0029LRSK60	Rear Lamp	121	1 576 963	0361LLED	Rear Lamp Round	106
1-FZELEK0497	0029LRSK60	Rear Lamp	121	363 716	0380L	Rear Lamp Round	106
062447	0195CUSB	Rear Lamp	117	8 510 443 7	0209LUS24V	Revolving Warning	153
063047	0195CUSB	Rear Lamp	117	85 104 437	0209LUS24V	Revolving Warning	153
063686	0195CUSB	Rear Lamp	117	1 279 289 7	0278LUS12V	Revolving Warning	153
ELO007-0016	0195CUSB	Rear Lamp	117	4 374 237	0322LUS12V	Revolving Warning	153
000-40.061	0195LL/RSB60	Rear Lamp	117	1 082 395	0322LUS24V	Revolving Warning	153
000-40.070	0195LL/RSB60	Rear Lamp	117	1 103 925 5	0322LUS24V	Revolving Warning	153
000-40.073	0195LL/RSB60	Rear Lamp	117	11 039 255	0322LUS24V	Revolving Warning	153
062774	0195LL/RSB60	Rear Lamp	117	2 174 120	0322LUS24V	Revolving Warning	153
063392	0195LL/RSB60	Rear Lamp	117	20002174120	0322LUS24V	Revolving Warning	153
ELO007-0004	0195LL/RSB60	Rear Lamp	117	20734485	0238LUS	Side Marker Lamp	42
1044276	0195LLSB60	Rear Lamp	117	84538758	0238LUS	Side Marker Lamp	42
062286	0195LLRSB60	Rear Lamp	117	20730342	E4215FH40	Spiral Cable	69
060562	0205LL51	Rear Lamp	118	21264638	E4215FH40	Spiral Cable	69
062374	0205LL51	Rear Lamp	118	21680280	E4215FH40	Spiral Cable	69
S060562	0205LL51	Rear Lamp	118	20409410	EN3853FU35	Spiral Cable	80
060561	0205LR51	Rear Lamp	118	3944910	EN3853FU35	Spiral Cable	80
S060561	0205LR51	Rear Lamp	118	20409412	ES3853FU35	Spiral Cable	80
062447	0284CU	Rear Lamp	116	355669	ES3853FU35	Spiral Cable	80
063047	0284CU	Rear Lamp	116	3944912	ES3853FU35	Spiral Cable	80
063686	0284CU	Rear Lamp	116	283941111A	0250LLEDZ	License Plate Light	48
ELO007-0016	0284CU	Rear Lamp	116	KDWHLO9201	0084CLED	Outline Marker Light	35
066404	0361LLED	Rear Lamp Round	106	KDWHLO9201	0084LEMKB	Outline Marker Light	35
1-FZELEK0211	0361LLED	Rear Lamp Round	106	KDWHLO9201	0123LEMKB	Outline Marker Light	35
740022	0361LLED	Rear Lamp Round	106	283 945 095 C	0205LL60	Rear Lamp	118
ELO007-0087	0361LLED	Rear Lamp Round	106	283 945 096 C	0205LL60	Rear Lamp	118
060515	0380L	Rear Lamp Round	106	283 945 096C	0205LR60	Rear Lamp	118
060071	0322LUS24V	Revolving Warning	153	283 945 223F	0205LR60	Rear Lamp	118
1152	0322LUS24V	Revolving Warning	153	283 945 232F	0205LR60	Rear Lamp	118
1-FZELEK0097	0322LUS24V	Revolving Warning	153	2E0 945 111	0360CLBB	Rear Lamp	109
063033	1651LUS	Side Marker Lamp	41	2E0945111A	0360CLBB	Rear Lamp	109
063083	1651LUS	Side Marker Lamp	41	2E0 945 096A	0360CRBB	Rear Lamp	109
1007810	1651LUS	Side Marker Lamp	41	2E0 945 095A	0360LBB742	Rear Lamp	109
618834	1651LUS	Side Marker Lamp	41	2E0 945 096A	0360LRBB742	Rear Lamp	109
R 060 198	1651LUS	Side Marker Lamp	41	100 941 022	0289LUS12V	Revolving Warning	155
1567 995	F3822KK16	Air Couplings	102	KDWHLO9577	0289LUS12V	Revolving Warning	155
1567995	F3822KK16	Air Couplings	102	690 941 087 A	0289LUS24V	Revolving Warning	155
1584 598	F3822KK16	Air Couplings	102	KDWHLO9024	0289LUS24V	Revolving Warning	155
1584598	F3822KK16	Air Couplings	102	KDWHLO9318	0322LUS12V	Revolving Warning	153
2046 7883	F3822KK16	Air Couplings	102	183 941 087	0322LUS24V	Revolving Warning	153
20467883	F3822KK16	Air Couplings	102				
8157 983	F3822KK16	Air Couplings	102				
8157983	F3822KK16	Air Couplings	102				
1505 064	F3822KK22	Air Couplings	102				
1505064	F3822KK22	Air Couplings	102				
20360898	0801FL	Headlamp	125				
20713720	0801FL	Headlamp	125				
20762994	0801FL	Headlamp	125				
20861583	0801FL	Headlamp	125				
21001663	0801FL	Headlamp	125				
20360899	0801FR	Headlamp	125				
20713721	0801FR	Headlamp	125				
20762993	0801FR	Headlamp	125				
20762995	0801FR	Headlamp	125				
20861582	0801FR	Headlamp	125				
20861584	0801FR	Headlamp	125				
21001662	0801FR	Headlamp	125				
21001668	0801FR	Headlamp	125				
8205 3690	0801YL01T	Headlamp	125				
82053690	0801YL01T	Headlamp	125				
8220 9788	0801YL01T	Headlamp	125				
82209788	0801YL01T	Headlamp	125				
8236 7098	0801YL01T	Headlamp	125				
82367098	0801YL01T	Headlamp	125				
8205 6986	0801YR01T	Headlamp	125				
82056986	0801YR01T	Headlamp	125				
8209 849	0801YR01T	Headlamp	125				

NOT :

WWW.SERTPLAS.COM.TR



@sertplas



facebook.com/sertplas



linkedin.com/company/sertplas

CENTER

İkitelli O.S.B. Mutsan 14. Cadde
M9 Blok No:9-11 34490
Başakşehir - İstanbul - TURKEY

+(90) 212 549 0555 Pbx

FACTORY

Laiklik Caddesi Haçer Sokak No:16
Büyükkılıçlı Köyü 34570
Silivri - İstanbul - TURKEY

+(90) 212 748 4586 Pbx